

AJILAB'AL MAYAB' K'ICHE' UROX JUNAB'



K'Yaqb'al Cholchi' Ixkanul	
JUN PA LE WOKOJ TZUK KIM POP	
3ra. Calle 15-25 zona 2, Totonicapán.	
Telefax: (502) 77661057	
Correo Electrónico: plsmc@gmail.com	
AJCHAKIB'	RI XECHAKUN CHECH LE UWOKIK WE WUJ
K'amal B'e:	K'amal B'e:
Obispo Rosales Yax	Obispo Rosales Yax
Tz'ib'anel:	
Imelda Soledad Tax Yax	
Ajilanel:	Tz'ib'anel':
Santos María López Cuá	José Viviano Batz Tzoc
Ilol Eta'manik:	Solinelab':
José Viviano Batz Tzoc	Obispo Rosales Yax
Timoteo Daniel Rosales Puac	Timoteo Daniel Rosales Puac
Angel Basilio Zapeta Tacam	
Tzukunelab' xuquje' Junam Wachil:	
Consuelo Juárez Pu.	
Nicolasa Angélica Puac	
Wokonel:	
Lilian Angélica Juárez Batz	
We Wuj ri', Xb'an kwinem xa malyox che ri utob'anik ri Cooperación Austriaca , chilib'etal chech le Instituto Norte Sur.	
Kuya'o kesak uwach we jun wuj, xaq xu che ri kya ub'ixikal le ub'i' le wuj xuquje' le wokoq b'anowinaq.	
We wuj ri' xsolixik xuquje' xya ub'e rumal le k'amalb'e rech le wokoq rech le eta'manik pa keb' ch'ab'al keb' no'jib'al rech Chwimiq'ina'.	

RI K'O CHUPAM WE WUJ		
	Jeqb'al Chak.....	4
1.	Ri ujeqeb'alil ri kino'jib'al ri e qati't qamam.....	5
2.	Le k'ulmatajinaq pwi' taq le uwokik le Ajilab'al Mayab'.....	6
3.	Ajilab'al Mayab'.....	6
4.	Jawi' taq kkoj le Ajilab'al Mayab' che taq we q'ij.....	11
5.	Jalajoj taq usuk'umal le Ajilab'al Mayab'.....	13
5.1.	Le uq'inomal utzijoxik le ajilanik pa qach'ab'al k'iche'.....	13
5.2.	Le ukojik le Ajilab'al Mayab' K'iche' che taq we q'ij kamik.....	16
5.3.	Le Ajilab'al Mayab' K'iche'	18
5.4.	Le ukojik le Ajilab'al Mayab' K'iche' are kjach le jastaq.....	24
5.5.	Le Ajilb'al Mayab' K'iche' kupaq'ij rib'.....	25
5.6.	Ajilab'al Mayab' K'iche' cholom ub'antajik.....	26
6.	Le chakunem pwi' taq le ajilab'al mayab' k'iche'.....	31
6.1.	Mulinem.....	31
6.2.	Esanem.....	40
6.3.	K'yarsanem.....	50
6.4.	Jachoj.....	58
7.	Le etab'al kokisax kamik qumal uj ujmayib'	69
8.	Wuj xe'solixik chech le uwokik we wuj.....	77

JEQB'AL CHAK

Le K'yaqb'al Cholchi' Ixkanul ktob' chuya'ik uchuq'ab' le eta'manik pa keb' ch'ab'al kya'taj pa taq le ja tijob'al rech le ukab' eta'manik tajin kchakux Chwimiq'ina' xuquje' Xelaju'.

Le kurayij le qanima' k'o ta b'anom wi we jun wuj Ajilab'al Mayab' K'iche' Urox Junab', k'i ktob'an chike ri taq ajtijab' xuquje' le ajtijoxelab' chech taq le jalajoj taq chak kkib'ano. Qeta'm chi k'i ri keta'mab'al ri e qati't qamam, qatzaqom kanoq, rumal la' tajin kqakoj qachuq'ab' rech, mata b'a ksach le je'la taq no'jib'al.

Chupam we jun wuj kriqitaj jastaq ri k'ulmatajinaq pwi' taq le uwokik le ajilab'al Mayab' K'iche'; jawi' kkoj wi che taq we q'ij; jastaq le usuk'umal le ajilab'al Mayab' K'iche'; le chakunem kb'an ruk' le ajilab'al Mayab' K'iche'; xuquje' le etab'al kokisax kamik qumal uj ujmayib' pataq le qachoch.

K'otab'a kupatanij we jun laj wuj ri' chike taq le ajtijab', ajtijoxelab' xuquje' le tat nan rech taq le komon, le kkiya uchuq'ab' le qano'jib'al uj ujmayib'.

Maltyox b'a chike ri eqachalal ri ke'tob'an ruk' le chak kub'an le K'yaqb'al Cholchi' Ixkanul pa taq le ja tijob'al, rech Ukab' Eta'manik, xa b'a rumal le kitob'anik, xujkwiniq xqawok chik we jun wuj, pa qach'ab'al K'iche'.

AJILAB'AL MAYAB' K'ICHE' **UROX JUNAB'**

1. RI UJEQEB'ALIL RI KINO'JIB'AL RI E QATI'T QAMAM.

Ri e qati't qamam, ri uj ujmajib', xkiwok jun nimalaj tinamit, waral pa we Iximulew xuquje' xu requele'j nik'aj taq e k'ulja tinamit, jachatane le México xuquje' le Honduras. Ri kino'jib'al ri e qati't qamam ri e mayib', sib'alaj nim. Sib'alaj k'i ri kichomab'al, ri ke'tamanik, rumal la' xekwinik xkiwok ri nima'q taq tinamit, jawje' xkiyak ri nima'q taq ja, ri kilitaj na kiwach kamik. Ri e qati't qamam ri e mayib', xkichakuj le ulew, xkitik le ixim, rachi'l le kinaq', ronojel ri xkitik choch ri uwachulew xajawataj chike pa ri kik'aslemal. Maltiyox che le qanan ulew konojel xe'k'asi'k rumal ri kiwa kuk'ya' xkitijo, rumal b'ala' xu'xik eko taq achyab', eko taq ixoqib'. Le k'ayin taq ixim, atz'am, raxataq ab'aj, rachi'l nik'ajtaq jastaq chik, are xe'tow che le kik'aslemal.

Ri e mayib' xkitzib'aj ronojel ri xk'ulmataj pa taq ri kik'aslemal xuquje' xkitz'ib'aj ri kk'ulmataj na. Sib'laj k'i ri jastaq xkitz'ib'aj kanoq, xak'u rumal che ri maj jun kwinaq chech ri usik'ixik, le jun taq wuj k'olotal kumal nik'aj taq winaq, jela' pa le uqajib'al q'ij rech we uwach ulew, pataq le tinamit Paris, Dresde, Madrid, kb'ixche. Sib'alaj k'i ri wuj jawje' kitz'ib'am ri kik'ulmam are xepe ri españolib' chiri' are jampa' xulik jastene jun eleq'om, xulkeleq'aj le jastaq qech xuquje' xkiproj ronojel ri je'lataq wuj.

Ri e mayib' xkisolij uwach ronojel le usuk'umal le uwach ulew, le uwach kaj, xkinik'oj uwach le requele'n le ik', le q'ij xuquje le e ch'umil choch we uwachulew, rumal la' xe'kwiniq xkiwok le cholq'ij, k'as na chqawach.

Ri e mayib' xkajilaj ronojel ri jastaq, xkitz'ib'aj ri xjawataj chike. Jalajoj taq xkikoq chech ri utz'ib'axik le ajilab'al are taq xetz'ib'an choch taq le wuj, choch taq le rax taq ab'aj. Le k'yaqal na chaqawach kamik are la' le kkoq chech le rajilaxik le q'ij, rachi'l nik'aj taq jastaq chik.

Le uk'a'malil le ajilab'al mayab', are le juwinaq. Are jampa' ko'pan jun pa juwinaq, kkib'ij ri e qati't qamam chi xaq jun ruk' le qak'o'jikal xuquje' le qakamikal choch we uwachulew.

2. LE K'ULMATAJINAQ PWI' TAQ LE UWOKIK LE AJILAB'AL MAYAB'.

Ktzijoxik chi ri e qati't, qamam, ri e mayib', are qas xkijeq ukojik retal ronojel ri jastaq kech ri xkajilaj, are xkikoj le alaj taq ab'aj. Xaq je ri' man xsachan taj chike are taq xeb'ek pa taq ri k'ayinem, ri loq'oj.

We xkik'ayij jumuch' raqan jas jun jasuch, kkik'ol jumuch' ab'aj, rech man ksach taj chike. We k'o xkiya pa taq k'asaj, je' xkib'an chech. Are k'u man utz taj xub'ano are sib'alaj k'i ri jastaq ri xkaj kajilaj kanoq, rumal chech le nim le k'olib'al kraj. Xaq je ri' xpe pa ri kichomab'al, ukojik le uwi' taq kiq'ab', uwi' taq kaqan chech le ajilanik. Rech b'a man ksachan taj pa kijolom jastaq ri xkajilaj, xkib'an alaj taq q'ab'aj, alaj taq aqanaj ruk' ri ab'aj, xaq je ri', we kkik'utu chi k'o juwinaq raqan jun jasuch, xa kkinuk' ri keb' alaj taq q'ab'aj, ruk' keb' alaj taq aqanaj. We jun no'jib'al ri' man qas ta xqaj chikiwach, rumal che ri xaq jewi k'ax umulixik sib'al ab'aj are jampa' k'i ri jastaq ri ajilanik ri kkib'ano, xaq je ri' no'jimal, xkitzaq kanoq.

Ri e qati't qamam, xkichomaj ukojik le kinaq' pa taq le nima'q taq ajilanik, rumalb'alo che ri xkisolij uwach le Pop Wuj, xkiriq k'ut chupam chi ri ojer taq achyab', ruk' tz'ite' xeb'an wi rumal ri Tz'aqol, B'itol. Le ajilanem xkib'an ruk' taq le kinaq' sib'alaj k'i xtob'an wi, rumal ri xpe pa kijolom uk'utik ruk' le job' raqan jas jun jasuch, ruk' le jun raqan kinaq' man ch'olom taj, rumal che ri kilom chi ri kinaq' ruk' le rij, job' kinaq' k'o chupam. Are jampa' xkaj xkik'ut le juwinaq, xaqxu xkixim le kajib' raqan kinaq' le man ch'olom taj. Xuk'utwachij chikiwach, le uwi' taq q'ab'aj, rachi'l le uwi' taq aqanaj, xkikoj kan ojer. Rumal la' k'o kkib'ij "k'al" che le juwinaq, xa rumal che ri kuk'utu jun k'ale'n kinaq'. No'jimal xkik'ex le ukojik le kinaq' le kuk'utwachij job' raqan, ruk' alaj taq che'. Rumal ri k'o jun taq junab' kk'is aninaq le ktijowik. Chi ri' kanajinaq kanoq le ukojik le kinaq', rachi'l le alaj taq che', are jampa' k'o kajilaxik. Chuk'isb'al rech, xkikoj le kotz'ij, are xkik'utwachij chi xu'b'opan pa juwinaq, e k'o qati't qamam are xkikoj le t'ot'.

3. AJILAB'AL MAYAB'

Le uk'a'malil le ajilab'al maya are le juwinaq. Le rajilb'alil le jalajoj taq ajilab'al mayab', k'o uk'exb'alil, pa taq le jalajoj taq k'olib'al jawi' kkoj wi. Le rajilb'alil le ajilab'al kawinaqirik are jampa' kapaqi'k. Kub'ano je ta ne ri k'o

jun nab'e, ukab', urox, ukaj, uro', k'olib'al, paqalem kub'ano xuquje' le rajilb'alil.

Le jalajoj taq ajilab'al mayab' tz'ib'atal ikim, kuk'ut chqawach, le rajilb'alil jacha le xqab'ij kan ajsik. Xuquje' kuk'ut chqawach le rajilb'alil pa le ajilab'al arábigo.

K'OLIB'AL	UK'IYARSANEM		RETAB'ALIL				
URO'	160,000	JUK'ALA'					•
UKAJ	8,000	JUCHUY				•	•
UROX	400	JUQ'O'			•	—	•
UKAB'	20	JUWINAQ	•	•	≡ [•]	≡ ^{••}	≡ ^{••}
NAB'E	1	JUN	•	≡ ^{••••}	—	•	—
			21	29	725	10,241	168,645

Le nab'e k'amb'al no'j, kuk'utwachij chqawach le juwinaq jun.

Le ukab' k'amb'al no'j, kuk'utwachij chqawach le juwinaq b'elejeb'.

Le urox k'amb'al no'j, kuk'utwachij chqawach le Juq'o', waqlajk'al, job'.

Le ukaj k'amb'al no'j, kuk'utwachij chqawach le Juchuy, joq'o', kab'lajk'al, jun.

Le ujo' k'amb'al no'j, kuk'utwachij chqawach le juk'ala' juchuy, juq'o' kab'lajk'al, job'.

LE KB'AN CHE LE UTZALQ'OMIXIK LE AJILAB'AL MAYAB' PA LE AJILAB'AL ARÁBIGO.

- Nab'e kanik'ox janipa' rajilb'alil le ajilab'al mayab' k'a te k'u ri' kakoj chuxuku le rejilb'alil k'o pa taq le k'olib'al, kak'iyisax ruk' le rajil taq le k'olib'al, kamulix ronojel le rajilb'alil, xaq je ri' kaqariq le rajilb'alil pa le ajilab'al arábigo.

a)  $17 \times 1 = 17$

b)  $6 \times 20 = 120$
 $4 \times 1 = + 4$

 124

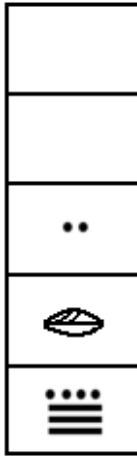
ch)  $2 \times 400 = 800$
 $0 \times 20 = 0$
 $19 \times 1 = + 19$

 819

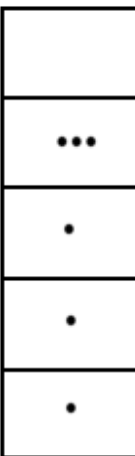
ch')  $3 \times 8000 = 24000$
 $1 \times 400 = 400$
 $1 \times 20 = 20$
 $1 \times 1 = + 1$

 24421

e)

•	1 x 160000 = 160000
•	1 x 8000 = 8000
☉	0 x 400 = 0
—	5 x 20 = 100
☉	0 x 1 = + 0
<hr/>	
168100	

i)

••	2 x 160000 = 320000
•••	3 x 8000 = 24000
••••	4 x 400 = 1600
☉	0 x 20 = 0
☉	6 x 1 = + 6
<hr/>	
345606	

CHAK:

Chatzalq'omij le jujun taq retab'alil ajilab'al mayab', pa le ajilab'al arábigo.

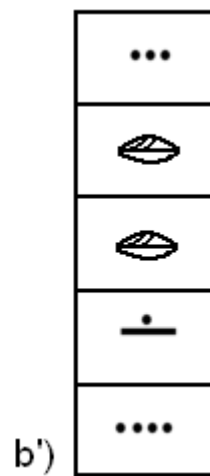
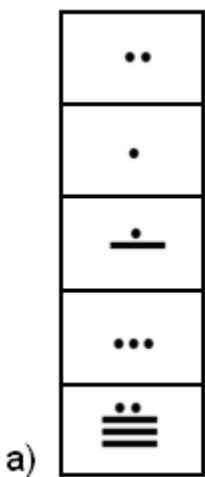

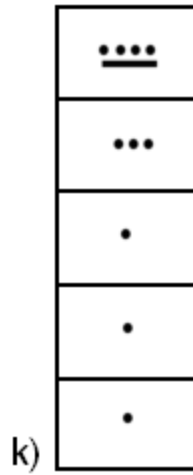
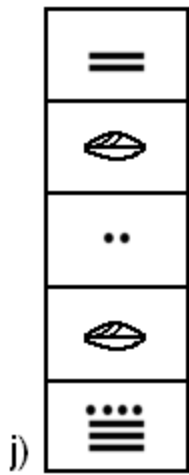
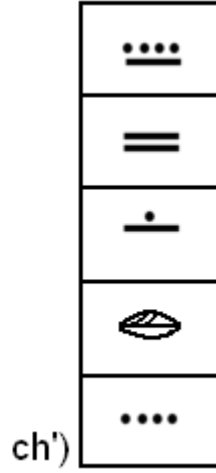
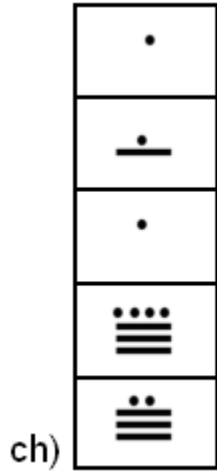

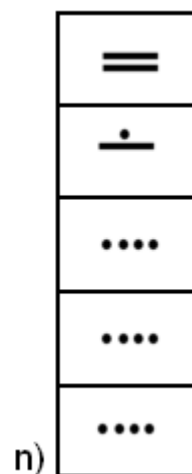
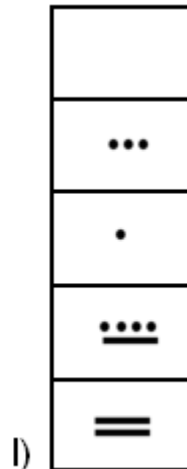
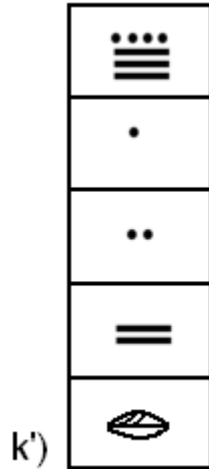

4. JAWI' TAQ KKOJ LE AJILAB'AL MAYAB' CHE TAQ WE Q'IJ.

4.1. LE UB'IXIKAL TAQ LE Q'IJ PA QACH'AB'AL

Pa le qach'ab'al uj mayib', are kqab'ij we xik'ow jun q'ij xuquje' are maja' kik'owik, kqaya ub'ixikal le rajilb'alil. Qilampe'.

Ojer kib'im ri qatat qanan chi xa ujulew poqlaj.

Junab'ir xinb'ij chawe chakojo' achuq'ab' che le achak.

Wuqub'ix ktz'aqat nujunab'.

Waqijir xik'ow le qanimaq'ij.

Kab'ajir xinwil uwach ri a Lu'.

Iwir xub'an jun nimalaj jab' jela' Chwimiq'ina'.

Mer xink'ulaj ri nunan pa ri b'e.

Kamik kul ri k'amal b'e rech le qatinamit.

Kab'ij kuje' pa k'ayinem, Xelaju'

K'a pa **oxij** q'ij katinsolij pa le achak.

Kib'im la' chqe le e qatat qanan **ojer**, xa uj wa' man qakojom taj retal.

Kna'taj chawe **junab'ir** xo'pan le ja' pa qachoch.

Kinb'ij chiwe, **wuqub'ix** k'o riqoj ib' pa le qakomon.

Xinwil uwach ri ali We'l **kab'ajir**, xutaq jun rutzil awach.

Utz uwach xinwil **iwir**, **kamik** kamem chik kub'ano.

Xink'ulaj **mer** pa taq le k'ulb'a't, xaq yowab' xinwilo.

Kamik kul le qanan.

Kino'pan pa awachoch **Kab'ij**.

Xqil uwach ri Lu' **oxijir**.

Kpe ri qatat **wuqub'ix**.

5. JALAJOJ TAQ USUK'UMAL LE AJILAB'AL MAYAB'

5.1. LE UQ'INOMAL UTZIJOXIK LE AJILANIK PA QACH'AB'AL K'ICHE'.

Chikiwach ri qati't qamam ronojel le jastaq k'o ub'e, k'o utzijoxik, k'o upatan xuquje' k'o kel kub'ij ri kipetik kib'antajik. Qilampe'.

LE JUN •

Kuk'utwachij, le utikitajik loq le uwokaj, le uwachulew xuquje' le xa jun qab'antajik choch we uwachulew. Le ja', le keqiq', le q'aq', le uwachulew, xa jun ruk'a'm rib'. Le q'ij, le uwachulew, le ik', le e ch'umil, xa jun kib'antajik choch we uwachulew.

LE KEB' ..

Kuk'utwachij le k'ulanem; kuk'utwachij le ixoq rachi'l le achi; kuk'utwachij le ati't rachi'l le ama'; kuk'utwachij le saqil rachi'l le q'equ'mal; kuk'utwachij ri kichuq'ab' ri qati't qamam; kuk'utwachij ri naj ri naqaj; kuk'utwachij le kamikal, le k'aslemal; kuk'utwachij le releb'al q'ij le uqajib'al q'ij xuquje' kuk'utwachij le keqiq', le tew le q'aq'; le kab'awil; le e yo'x; le yo'x che'; le Tz'aqol, B'itol; le Alom K'ajolom.

LE OXIB' ...

Kuk'utwachij ri utikitajik loq le e loq'alaj taq che', ronojel ri jalajoj taq q'ayes xe'poq' loq rumal ri qajaw; kuk'utwachij le uwachulew, le kaj xuquje' le xib'alb'a. Che taq we q'ij, kuk'utwachij le ixim, le kinaq' xuquje' le mukun. Le q'ij, le ik' xuquje' le uwachulew. Le xuk'ub' kkikoj le qanan are knuk' le q'aq'; xuquje' kuk'utwachij le raqan le ka'.

LE KAJIB'

Kuk'utwachij le uxukut kaj, uxukut ulew; le yab'al taq k'aslemal: q'aq', ja', kaqiq', ulew; le loq'alaj taq eqanel junab': No'j, Kej, Iq', E; le ukayeb'al le loq'alaj qanan ixim: kyaq, raxwa'ch, saq, q'an; ri e kajib' e qati't, kajib' e qamam; le ub'inib'al le qati't ik' xuquje' le qatat q'ij; ri utikik kaj ulew rumal ri qajaw; ri utikik ri winaq cvhiu uwach ri q'ijsaq; le releb'al q'ij, le uqajib'al q'ij, le releb'al keqiq' xuquje' le uk'olib'al ja'; le uka'uib'al le qakik'el, qawi', qatz'u'mal, qab'aqil.

LE JOB' —

Kuk'utwachij le uwi' qaq'ab'. Kuk'utwachij le kajib' uxukut le uwachulew, ruk' le upanik'ajilal. Kuk'utwachij le job' q'ij ub'ina'm wayeb' tz'aqatisab'al rech le jun junab' pa le cholq'ij.

LE WAQIB' ◡

Kuk'utwachij le UK'u'x Kaj, UK'u'x Ulew, UK'u'x ureleb'al q'ij, UK'u'x uqajib'al q'ij, UK'u'x releb'al keqiq' xuquje' le uk'u'x uk'olib'al ja'.

LE WUQUB' ◢

Kuk'utwachij le qaxikin, le qab'oq'och, le qatza'm xuquje' le qachi'. Kuk'utwachij le le waqq'o'b'al kkoj pa le mayab' k'aslemal (raxkaj, raxulew, kyaq, q'eq, saq, q'an).

LE WAJXAQIB' ◣

Kuk'utwachij le ujeqb'alil uk'aslemal le winaq, ujeqb'alil nima'q taq q'ij chak xuquje' jalajoj taq k'ulmatanem chi uwach q'ijsaq; jalb'al uwach uq'ijol le qati't ik'.

LE B'ELEJEB' ☸☸☸

Kuk'utwachij le utikik le Mayab' winaq ruk' le qanan ixim; tz'aqatisab'al chak patan; jeqb'al-tz'apib'al chak patan chi uwach q'ijsaq; le maltyoxinik. Kuk'utwachij le qaxikin, le qab'oq'och, le qatza'm, le qachi' xuquje' jawi' kel wi le nima chuluj, le xaq chuluj.

LE LAJUJ =

Kuk'utwachij le usolik ukirik uwach uk'aslemal jun winaq (ch'akulil-no'jnab'alil-kojb'alil); le rik'ilal-uq'ijol-uch'umilal ruk' eqanel junab' rech jun winaq; le ujachom wi rib' le loq'alaj cholq'ij pa uch'akul jun winaq (B'atz' k'a Ajpu j'o pa qaq'ab', Imox k'a Tz'i' k'o pa qaqan), uwi' raqan uq'ab' le winaq xuquje' keb' oxib' awaj.

LE JULAJUJ ≡

Kuk'utwachij le uk'an ib' pa komon winaqil, le ukemik uwach le q'ijsaq, le tojonik.

LE KAB'LAJUJ ≡

Kuk'utwachij le wokib'al kachoch kik'olib'al ri e qati't qamam; uchuq'ab'il komon winaq; k'isb'al jeqb'al no'jib'al.

LE OXLAJUJ ≡

Kuk'utwachij le usaqilal uno'jib'al le winaq, uchuq'ab'il le juwinaq q'ij rech le cholq'ij; le animal eta'mab'al, tz'apib'al no'jib'al.

Kuk'utwachij le oxlajuj jawi' utiqemrib' le qab'aqil. Qilampe'.

Keb' umopil qaqan.

Keb' qach'ek.

Keb' qachaq.

Keb' uqul qaq'ab'.

Keb' qach'u'k.

Keb' qateleb'.

Le qaqul.

LE JUWINAQ

Kuk'utwachij le uwi' qaq'ab', le uwi' qaqan; le ajilab'al mayab', le ik' k'o juwinaq q'ij chupam; le kib'i' le q'ij pa le cholq'ij.

Le ajilab'al kkoj na che le ajilanik pa taq le komon kumal le e qatat qanan, are la' le qab'im chik chi k'o uk'a'malil juwinaq. Xaq ek'yaqal chik ri e qatat qanan kkikoj le ajilab'al mayab'. Utz we kqaya uchuq'ab' le ajilab'al mayab'. Qakojo' pa taq le qarajawaxik, rech xaq je ri' man kkam taj le ajilab'al mayab' k'iche'.

5.2. LE UKOJIK DE AJILAB'AL MAYAB' K'ICHE' **CHE TAQ WE Q'IJ.**

PA TAQ LE PATAN

Chike le Ajq'ijab' sib'alaj k'o kupatanij le ajilab'al mayab', are jampa' kkib'an le patan. Che ri' kkina'taj le juwinaq q'ij k'o pa le jun ik' xuquje' le oxlajuj uchuq'ab'il are ktz'on le jororemal rech le uwachulew xuquje' qech uj. Are kkiq'atuj chech le loq'alaj q'aq' kkina'taj le juwinaq rumal che ri ruk'a'm rib' ruk' le uwachulew. Ri qati't qamam, are kkimulij ronojel ri

kichakub'al, kkiq'atuj ruk' le kinaq', kkajilaj le juwinaq ruk' le oxlajuj, rech ku'tzaqa' oxlajk'al q'ij rech le cholq'ij, le kuya usuk'umal le qak'aslemal.

PA LE CHOLQ'IJ

Le ajilab'al mayab' kkojik are jampa' kaya ub'ixikal le uchuq'ab'il le q'ij kajilaxik pajujunal ko'pan pa oxlajuj. Are kya ub'ixikal le ik' cholom chiqawach. Are kya ub'ixikal le jalajoj taq nawal.

PA TAQ LE QARAJAWAXIK

Le ajilab'al mayab' kkoj kamik pa taq le k'ayib'al are kb'an le loq'oj. Ek'i ri e qati't qamam man kitzaqomtaj le ukojik le ajilab'al mayab', rumal la' ktatajik chi k'o kkib'ij:

- ¿Chaya kab'lajuj raqan walanxax ali!,ja'e nan, ri';
- ¿Janipa' k'ula' le nuk'as awuk' ala?, waqib' ketzal tat;
- ¿Janipa' taq le pajb'al che le pix?, ¿oxib' ketzal!, ¿keb' la' nan!, ¿utz la' chamab'ik!;
- ¿janipa' le awech kb'ek?, ¿cha ya job' pajb'all.

PA TAQ LE UYAKIK LE JALAJOJ TAQ CHAK

Le qatat qanan, are kkiyak le jalajoj taq ja, kkiyak le q'a'm, kkib'an le b'e, kkikoj le ajilab'al mayab'. Are kkiyak jun ja, nab'e kkichomaj ri unimal ri ja, k'ate ri' ko'k chech ri uchomaxik joropa xan, joropa tz'alam, joropa xot, joropa tem, joropa che', joropa pwaq kuk'amb'ik le uyakik le ja.

We xchomataj kumal k'ate ri' kkib'ij, kqab'an jun laj qachoh re kab'lajuj b'ara; kjawataj chaqe oq'o' qaxan; wuqq'o' lajk'al qaxot, juwinaq waqlajuj qatem, jumuch' qache', oxib' uchi' ja, oxib' wenta'n, job' pajb'al qaklawux.













ARE KB'AN TAQ LE TIKO'N





Are kkb'an ri jalajoj taq tiko'n le e qatat qanan, teren la' le ajilab'al mayab' kuk'. Qila' jas kkib'an che ri ukojik le ajilab'al.

Wuqub'ix kinb'e pa chak ruk' le nan We'l, ke'n b'ana le rawex, oxlajuj k'a'm le rulew ke'ntika'. Wuqub' raqan ixim kqaya kan pa taq le mul. Jun raqan kinaq', kqaya kan chuxo'l le ixim. Kqaya oxib' uxo'l k'ate ri', kqaya kan jun sakil chikixo'l le ixim xuquje' le kinaq'. We xb'antaj le jach', le qatat qanan kkajilaj janipa k'at jal xkimulij, xaq je ri' kkib'ij, che we jun junab' ri' le qulew xuya kawinaq kab'lajuj k'at jal, jo'k'al raqan q'oq', jumuch' raqan mukun, waqib kintal kinaq'.

5.3. LE AJILAB'AL MAYAB' K'ICHE'

AJILAB'AL MAYAB' K'ICHE'		
AJILAB'AL '	RETAB'ALIL	
Jun	•	1
Keb'	••	2
Oxib'	•••	3
Kajib'	••••	4
Job'	—	5
Waqib'	—•	6

Wuqub'		7
Wajxaqib'		8
B'elejeb'		9
Lajuj		10
Julajuj		11
Kab'lajuj		12
Oxlajuj		13
Kajlajuj		14
Jo'lajuj		15
Waqlajuj		16
Wuqlajuj		17
Wajxaqlajuj		18
B'elejlajuj		19

Juwinaq	• 	20
Juq'o'	• • 	400
Juchuy	• • • 	8,000
Juk'ala'	• • • • 	160,000

CHAK:

Ruk' le ajilab'al mayab' k'iche' xchol chqawach, chatz'ib'aj, janipa' rajilb'alil le jalajoj taq retab'alil kk'ut chawach.

Le jun k'amb'al no'j kuk'utwachij, le usuk'umal le chak.

...



Oxk'al kajlajuj.

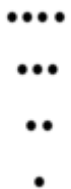
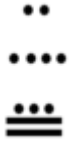

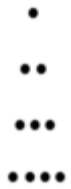

CHAK:

Chatz'ib'aj le retab'alil le jalajoj taq ajilab'al mayab' k'iche'.

Le jun k'amb'al no'j kuk'utwachij, le usuk'umal le chak.



Lajk'al b'elejlajuj



Jo'lajk'al jo'lajuj



Juq'o jok'al kab'lajuj

Oxq'o' oxk'al waqlajuj

Wajxaqlajq'o' kawinaq job'

Juchuy juq'o' jo'k'al

B'elejlajq'o' b'elejlajuj

Oxlajq'o' juwinaq b'elejlajuj

Wuqq'o' wuqk'al wuqub'

B'elejk'al b'elejlajuj

Lajq'o' juwinaq jun

5.4. LE UKOJIK LE AJILAB'AL MAYAB' K'ICHE' ARE KJACH LE JASTAQ.

Ri qatat qanan kkikoj le jalajoj taq ajilab'al are kkijach jastaq. Qilampe' jas le kk'ulmatajik, are kya'taj pa taq le qak'aslemal.

- Chaya **jujun** kikaxlanwa le ak'alab'.
- Le achyab' xuquje' le ixoqib' kya **kakab'** kikaxlanwa.
- Le enima'q taq winaq, kya **ox ox** kikaxlanwa.
- Le ek'amalb'e kaya **kakaj** kikaxlanwa.
- Le kitat le ak'alab' xuya **kakab'** k'a'm kulew.
- Le ajtij xujach **kakaj** qawuj, kjawataj chqe pataq le qachak.
- Chwe'q kik'amloq **job' raqan** si' chi **ijujunal**.
- Chik'amab'ik **wajxaqib' raqan** tz'alam **chi ijujunal**, kiya kan ruk' le ajanel.
- Xaq e **ox ox** ke't'uyi' b'ik pa taq le ut'uyulib'al le ch'ich'.
- Qa k'ama b'ik **kakab'** qech le choma'q taq ab'aj.
- Xa **waqib' raqan** qawa xjach chqe **chi qajujunal** rech jun q'ij.

CHAK:

Chatz'ib'aj jujun taq cholaj tzij jawje' kkoj le ajilab'al mayab' k'iche' are kajach jastaq. Chachomaj, k'ate ri' katz'ib'aj.

5.5. LE AJILAB'AL MAYAB' K'ICHE' KUPAQ'IJ RIB'

Pa taq le jalajoj taq kirajawaxik le e qatat qanan, k'o jun taq mul kkipaq'ij uwach taq le ajilab'al. Qilampe' jas kkib'an chech ri upaq'ixik taq le ajilab'al.

- Xwan cha pusu' le jun alanxax pa **nik'aj**, kaya jun ch'aqa'p kech le atan anan.
- Qapaq'ij pa kajib' we jun kintal ixim, qasipaj jutaq b'iq' kixim ri e qalk'wa'l.
- Chajacha' we jun q'uuq' chikiwach we job' ak'alab', junam kab'an chikech.
- A Lu', ¡chayakan nik'aj tarey nu si'!
- Alí ¡chak'ayij kajib' onsa nuk'oxob'!
- ¡Chayab'ik keb' onsa nuq'ax!
- ¡Paja la oxib' arroba wixim!
- ¡Qaloq'ob'ik jun arroba qakinaq'!

- ¡Kaloq'la nik'aj pajb'al qati'!
- Xujb'inik nik'aj lewa chiqaqan, k'ate ri' xe'qariqa' le rachoch le ajkun.

CHAK:

Chatz'ib'aj jujun taq cholaj tzij, jawi' kakoj wi le jalajoj taq ajilab'al mayab' ri kupaq'ijrib'. Jachatane le jujun taq cholaj tzij xqil kanoq.

5.6. AJILAB'AL MAYAB' K'ICHE' CHOLOM UB'ANTAJIK

Le e qati't qamam, are kkichol ri kkib'ano, k'o ub'ixikal kumal. Chujokampe chech ri urilik xuquje' unik'oxik le enab'e taq ajilab'al kuchol chqawach le jastaq kb'anik.

Nab'e	•	1º.
Ukab'	••	2º.
Urox	•••	3º.
Ukaj	••••	4º.
Uro'	—	5º.
Uwaq	• —	6º.
Uwuq	•• —	7º.
Uwajxaq	••• —	8º.
Ub'elej	•••• —	9º.

Uljaj		10°.
Ujulaj		11°.
Ukab'laj		12°.
Roxlaj		13°.
Ukajlaj		14°.
Ro'laj		15°.
Uwaqlaj		16°.
Uwuqlaj		17°.
Uwajxaqlaj		18°.
Ub'elejlaj		19°.
Ujuwinaq		20°.

Qilampe' jas ukojik le ajilab'al mayab' k'iche' cholom ub'antajik kumal le e qatat qanan.











- **Nab'e** kinb'e in k'ate ri' katb'e at.
- **Ukab'** rachajil le k'o kuk' kamik le ali Mate'y.
- K'a churox mul xya le ali che le Axwan.
- Le wal ala k'o pa **ukaj** junab' pa le ja tijob'al rech nab'e eta'manik.
- Le wal ali k'o pa **uro'** junab' pa le ja tijob'al rech ukab' eta'manik.
- Le nuk'ojol k'o pa **uwaq junab'**, pa le ja tijob'al rech ukab' eta'manik.
- Le Atun xwarik pa le **uwuq** q'at rech le jun ja.
- Iwir xine'xik'ana Xelaju', xinkwinik xinopan pa le **uwajxaq** k'olib'al.
- Le Apa'x xuch'ek le **ub'elej** k'olib'al.
- Chicholo' iwib' ak'alab', jachin le k'o pa le **ulaj** k'olib'al, kape jewa'.









- Le k'o pa le **ujulaj** k'olib'al kutz'ib'aj ronojel ri kk'ulmataj pa we jun etz'anem kqab'ano.
- Le **ukab'laj** wal xaq xk'oji'k, xkamik.
- Le ali Carmen k'a chu **roxlaj** k'olib'al xkanajik pa le jun cholwa'katem.
- Xe chololex konojel ri alab'om, **chukajlaj** k'olib'al, xriqitaj le jun wuj rech le ajtij xsachik pa le ja tijob'al.
- At kate' pa le **ro'laj** k'olib'al ma sachan chawe.
- Iwir xinb'e ruk' le ajkun, pa le **uwaqlaj** k'olib'al xinokik ruk' le ajkun.
- ¡Je le nunan in k'ate xokik pa le **uwuqlaj k'olib'al** ruk' le ajkun!, teren b'a ri' chwij, xa man xinwil taj.
- Pa le **uwajxaqlaj** q'ij rech we ik' kujb'ek pa k'ich'elaj.
- Pa le **ub'elejlaj** q'ij rech le ik' xik'ow kanoq, xtz'aqat kawinaq nujunab'.
- Pe le **ujuk'al** junab' uk'ulanem le ali Talin, xkwiniq xuyak le rachocho.



CHAK:

Chatz'ib'aj jujun taq cholaj tzij ri kumajo kkoj le ajilab'al mayab' k'iche' cholom ub'antajik.

Kuya'o we kqaj kqanimarisaj le ukojik le ajilab'al mayab' k'iche' cholom ub'antajik. Qilampe' jujun taq k'amb'al no'j.

Ukak'al		40°.
Ukawinaq b'elejlajuj		59°.
Uroxk'al		60°.
Ukajk'al – Ujumuch'		80°.
Uro'k'al		100°.
Uro'k'al jun.....		101°
Uwaqk'al		120°....
Uwuqk'al		140°....
Uwajxaqk'al - ukamuch'		160°....
Ub'elejk'al		180°....

Ulajk'al		200°....
Ujujlajk'al		220°.....
Ukab'lajk'al (uroxmuch')		240°....
Uroxlajk'al		260°.
Ukajlajk'al		280°....
Uro'lajk'al		300°.
Uwaqlajk'al (Ukajmuch')		320°.....
Uwuqlajk'al		340°....
Uwajxaqlajk'al		360°.....

Ub'elejlajk'al		380°....
Ujuq'o' - Uro'much'-		400°.
Ujuq'o' jun - Uro'much' jun		401°.....

6. LE CHAKUNEM PWI' TAQ LE AJILAB'AL MAYAB' K'ICHE'

6.1. LE MULINEM

Are kujqaj chech ri umulixik ri jastaq kajawataj chqech pa taq le qarajawaxik, kuya'o kqatz'ib'aj joropa raqan ri kaqamulij, k'ate ri' kqab'an xa jun chech le kaqamulij, rech kaqeta'maj joropa raqan kuya chiqawach.

Qab'im chik chi le retab'alil le tunuj are le jun wachib'al kuk'utwachij le salq'um are kuk'am b'ik ronojel le kuriq pa le ub'e.

Qilampe' le jun k'amb'al no'j, jas kb'an chech le usolixik le mulinem:

- Nab'e ke'nuk' konojel le ajilab'al le e k'o pa le nab'e k'olib'al k'ate k'uri' keq'at le alaj taq t'orot'a'q xuquje le alaj taq juch'.

- Ke'nuk' konojel le ajilab'al le e k'o pa le ukab' k'olib'al xuquje' kq'at le alaj taq t'orot'a'q xuquje' le alaj taq juch'.
- Ke'nuk' konojel le ajilab'al le e k'o pa le urox k'olib'al, keq'at le alaj taq t'orot'a'q xuquje' le alaj taq juch'.
- Kajilaxik konojel le e t'orot'a'q xuquje' le e juch' e k'o pa le nab'e k'olib'al, we ko'pan pa job' le e t'orot'a'q, kk'exik ruk' jun juch'; kajilaxik konojel le alaj taq juch', we ko'pan pa kajib', kk'exik ruk' jun laj t'orot'ik k'ate k'uri' kpaqab'ax pa le jun k'olib'al chik.
- We xb'an to'tajem chech taq le ajilanem xuquje' le k'exoj, rajawaxik knik'ox uwach we rajawaxik kq'axax le retab'alil le ajilab'al pa jun k'olib'al chik.

Qilampe' le e k'amb'al no'j.

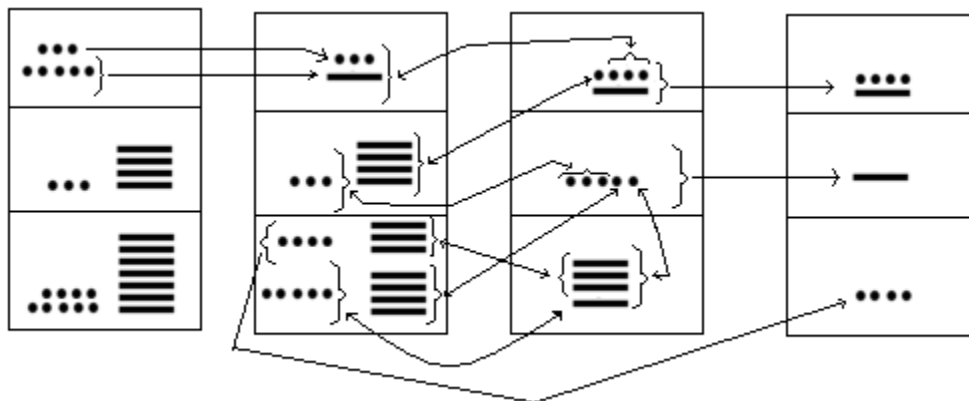
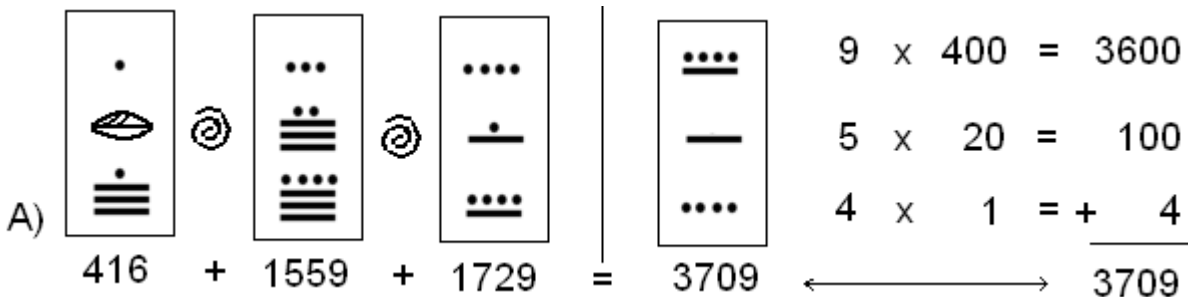

B')

1937	1559	1789	=	5285	$13 \times 400 = 5200$ $4 \times 20 = 40$ $5 \times 1 = 5$ <hr style="width: 100px; margin-left: 0;"/> 5285
------	------	------	---	------	--

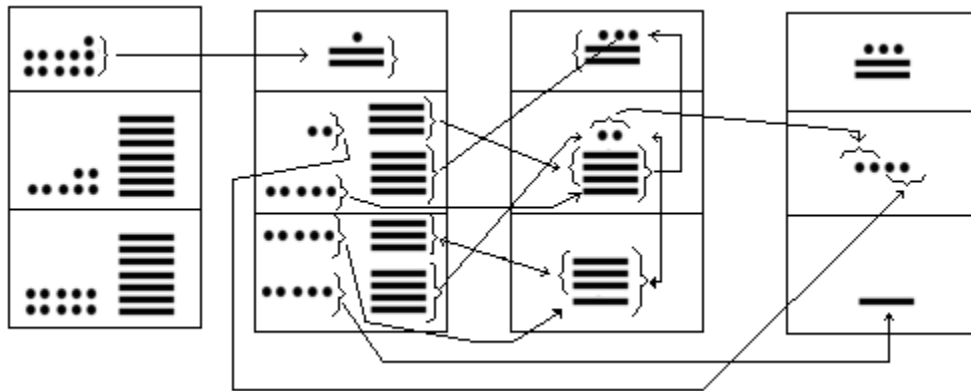

CHAK:

Chasolij le jalajoj taq mulinem. Chatzukuj le tzalib'al uwach.

a)

b)

ch)

ch')

e)

CHAK:

Chasolij le jalajoj taq mulinem. Chatzukuj le tzalib'al uwach.

- a) Jun achi xuk'ayij pa jun q'ij, **juq'o' raqan alanxax**, pa jun q'ij chik xuk'ayij **oxq'o' raqan alanxax**. ¿Joropa' alanxax xuk'ayij pa le keb' q'ij le jun achi?

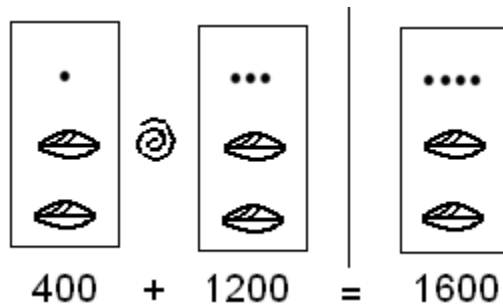

TZALIB'AL UWACH: le jun achi, xuk'ayij **kajq'o'** alanxax pa le keb' q'ij.

- b') Jun ajk'ay atz'yaq, xrajilaj ri urajil xumulij rech taq ri uk'ay, pa le nab'e q'ij xumulij **wuqk'al q'uq'**, pa le ukab' q'ij xumulij **lajk'al wuqub'**, pa le urox q'ij xumulij **kab'laj k'al q'uq'**. ¿Joropa' pwaq xumulij ri achi?

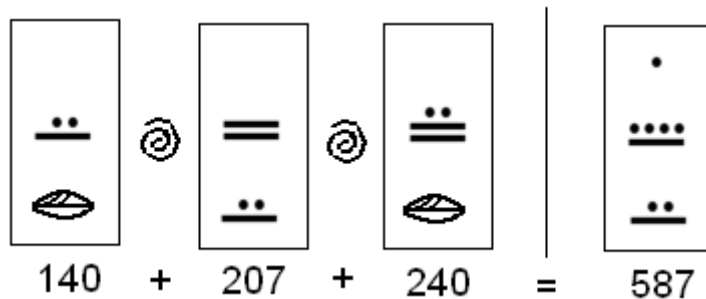

TZALIB'AL UWACH: le achi xumulij **juq'o' b'elejk'al wuqub'** ketzal.

ch) Jun chuchu' e k'o **kawinaq lajuj raqan rak'** pa le jun rachoch, **b'elejlajuj** pa le jun rachoch chik, k'ate ri' xuloq'o **jo'k'al b'elejlajuj** raqan ak' chech jun rachalal. ¿E jorapa' le rak' le jun chuchu'?

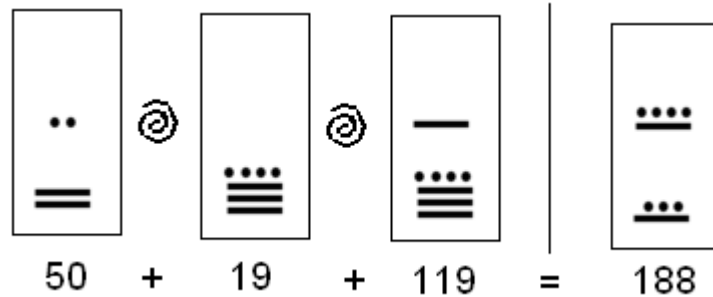

TZALIB'AL UWACH: e b'elejk'al wajxaqib' le rak' le jun chuchu'.

ch') Pa jun ja tijob'al rech ukab' eta'manik e k'o **wajxaqk'al waqib' ajtijoxelab'** pa le nab'e junab'; **wuqk'al kajib' ajtijoxelab'** e k'o pa le ukab' junab', **jo'k'al lajuj ajtijoxelab'** e k'o pa le rox junab'. ¿E joropa' le ajtijoxelab' e k'o pa le jun ja k'olib'al?

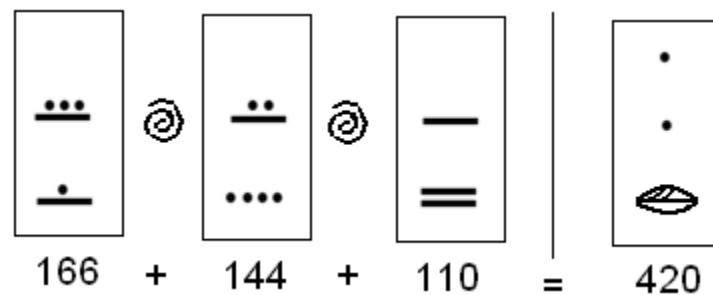

TZALIB'AL UWACH: pa le jun ja tijob'al e k'o **juq'o' juwinaq** ajtijoxelab'.

e) Jun ch'ich' xub'inib'ej **b'elejlajk'al lajuj** kilometro pa jun q'ij, **juq'o' juk'al** kilometro pa jun q'ij chik, **juq'o' jo'k'al b'elejeb'** kilometro chech le jun q'ij chik. ¿Janipa' kilometro xub'inib'ej le jun ch'ich' pa le oxib' q'ij?

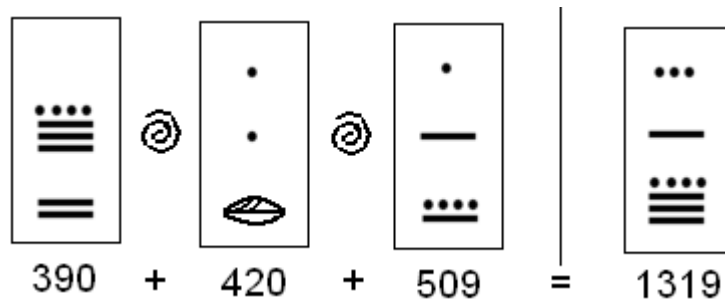

TZALIB'AL UWACH: le jun achi, xub'inib'ej **oxq'o' jo'k'al b'elejeb'**.

CHAK:

Chasolij le jalajoj taq mulinem. Chatzukuj le tzalib'al uwach.

a) Jun ch'ich' xub'inib'ej pa ri kaj **kaq'o' juwinaq** (820) kilometro pa le nab'e q'ij; pale uk'ab' q'ij xub'inib'ej **joq'o'** (2000) kilometro; pa le urox q'ij xub'inib'ej **wuqq'o' lajk'al** (3000) kilometro. ¿Janipa' kilometro xub'inib'ej cho kaj le jun ch'ich'?

TZALIB'AL UWACH: le jun ch'ich' xub'inib'ej _____ kilometro cho ri kaj.

b') Jun achi xuloq' jun kowilaj kej chi **jo'q'o' jo'k'al** (2100) ketzal; xuquje' xuloq' jun wakax chi **jo'lajq'o'** (6000) ketzal; xuloq' jun b'ur chi **oxq'o' jo'lajk'al** (1500) q'uj'. ¿Janipa' ketzal xusacho le jun achi?

TZALIB'AL UWACH: le jun xusacho _____ q'uj'.

ch) Jun achi k'o **lajk'al** (200) k'a'm rulew uyo'm pa qajomal, **jo'lajk'al job'** (305) k'a'm rulew tajin kutiko; **jumuch' wajxaqib'** (88) rulew man tajin kutik taj. ¿Janipa' k'a'm rulew le jun achi?

TZALIB'AL UWACH: le jun achi k'o _____ k'a'm rulew.

ch') Jun ajk'ay ti'j uya'om pa k'asaj **wuqk'al oxib'** (143) q'uq' ti'j chike le ajk'ay taq wa; **juq'o' jok'al job'** (505) ketzal ti'j chike taq le umarcha'n; **kab'lajk'al** (240) q'uq' ti'j chike taq le erachalal. ¿Janipa' q'uq' uya'om pa k'asaj le jun ajk'ay ti'j?

TZALIB'AL UWACH: le jun ajk'ay ti'j uya'om _____ q'uq' ti'j pa k'asaj.

e) Jun tata' xuyak **kaq'o' jo'k'al** (900) raqan oj pa jun che'; kajq'o' (1600) xuyak pa jun che' chik; juq'o' lajk'al (600) xuyak chech jun che' chik. ¿Janipa' raqan oj xuyak le jun tata', chijunamal?

TZALIB'AL UWACH: le jun tata' xuyak _____ raqan oj chijunamal.

6.2. ESANEM

Are kujqaj chech ri uresaxik ri jastaq kajawataj chqech pa taq le qarajawaxik, kuya'o kqatz'ib'aj joropa' raqan, ri kkanaj kanoq, rech kqe'tamaj joropa' raqan ku'tzaqa' chqawach.

Le retab'alil le esanem are le jun wachib'al kuk'utwachij jun ixkanul qupim le uwi'.

Are kujqaj chusolixik le chak rech esanik, rajawaxik kqakoq retal jas kab'an chech.

Qilampe' jas kb'an chech:

- Nab'e kasolix le ajilab'al k'o pa le nab'e k'olib'al.
- Le ajilab'al k'o pa le qawiq'ab' kub'ij joropa' kesaxik chech le ajilab'al k'o pa le qamox.
- We man ku'b'ana' le ajilab'al k'o pa qamox, kuya'o kujqajan ruk' le ajilab'al k'o pa le jun k'olib'al ajsik.
- Pa le k'amb'al no'j man kuya taj kelesax b'elejlajuj chech le waqlajuj. Rech kuya'o, kuqajna juwinaq chech le ajilab'al k'o pa le k'olib'al ajsik, xaq jeri' kub'ana' juwinaq waqlajuj. Le kesaxik are le wuqlajuj.
- Kasolix le ajilab'al k'o pa le ukab' k'olib'al. Pa le k'amb'al no'j le ajilab'al k'o pa le qawiq'ab' karaj kuresaj wuqlajk'al che le k'o pa le qamox. Qab'ana chech chi xa wuqlajuj le karesaj chech le ajilab'al k'o pa qa mox.
- Kqilo chi man kuya' taj, xaq je ri' kqaqaj na juq'o' chech le ajilab'al k'o ajsik. Qab'ana chech chi xa juwinaq le qajanik kab'anik.
- Ka na'taj chaqe chi k'o jun xuqaj le ajilab'al k'o ikin xaq je ri' re rajilb'alil le ajilab'al are le b'elejlajuj.
- We kesax wuqlajuj chech le b'elejlajuj kakanaj kanoq keb'.

- Qila' le ajilab'al chijunamal. We kquesaj wuqlajk'al b'elejeb' chech le juq'o' waqlajuj, kakajanaj kawinaq wuqlajuj.

K'amb'al no'j:

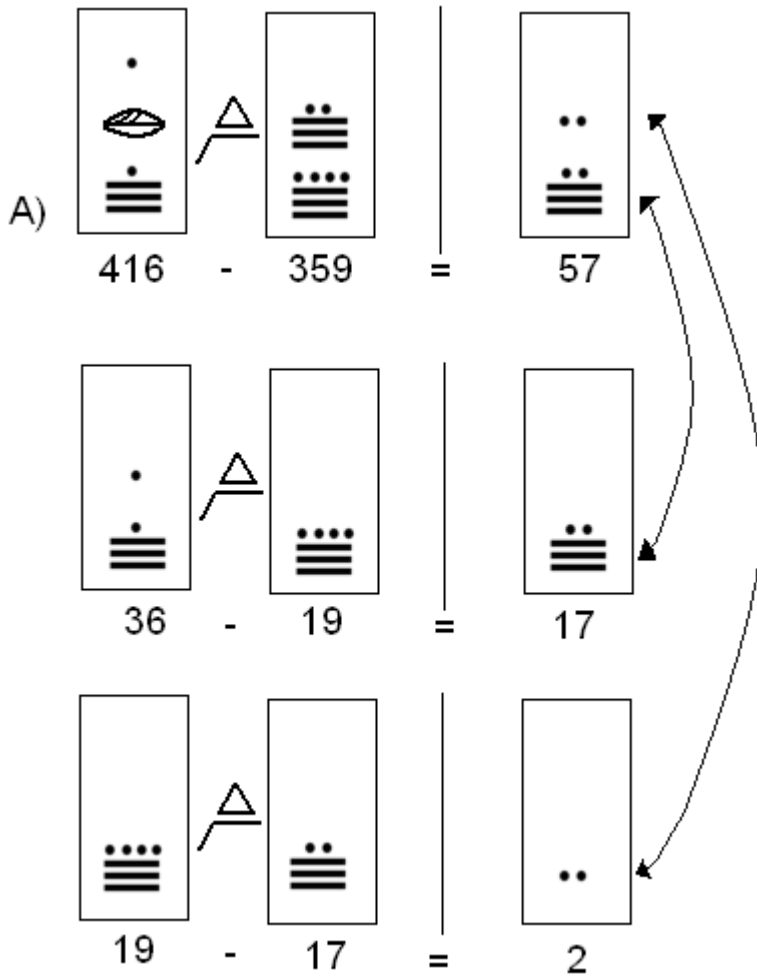

CHAK:

Chasolij le jalajoj taq esanik. Chatzukuj le tzalib'al uwach.

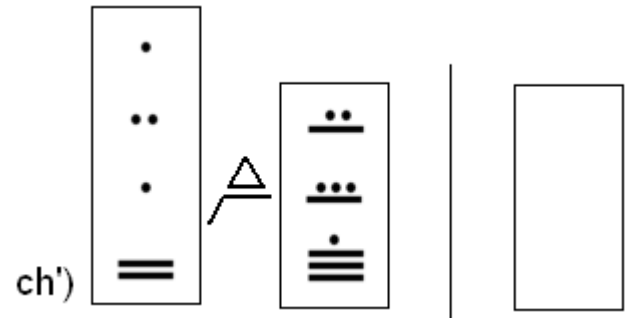
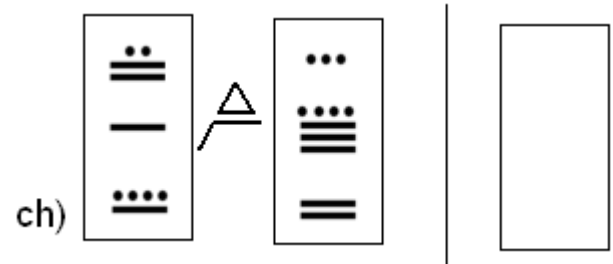
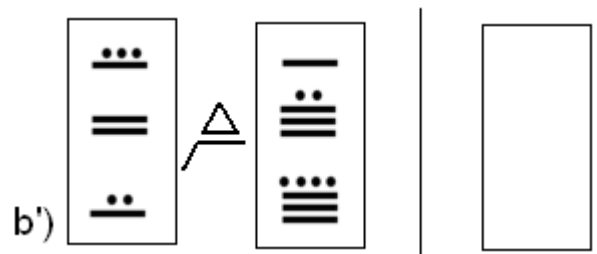
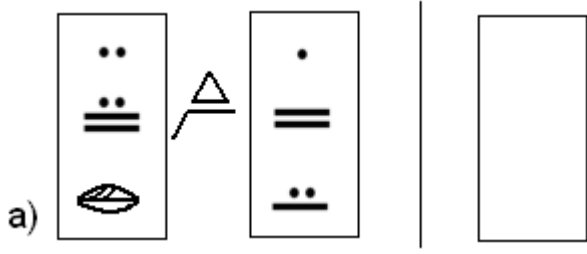

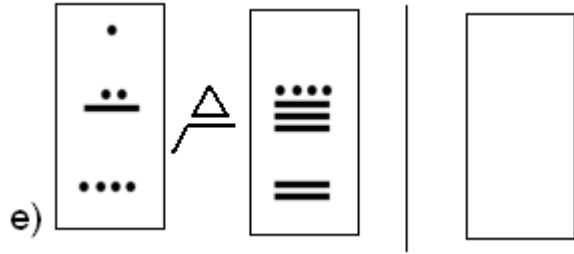

CHAK:

Chasolij le jalajoj taq esanik. Chatzukuj le tzalib'al uwach.

a) Jun achi xuloq'o **juq'o' jo'k'al kab'lajuj** raqan oj; **jo'k'al** raqan oj xe'q'ayik. ¿Joropa' raqan oj utz xe'lik?

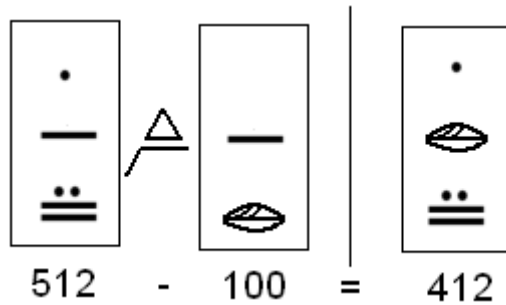

TZALIB'AL UWACH: **juq'o' kab' lajuj** raqan oj utz xelix.

b') Jun achi xuloq' **juq'o' b'elejlajk'al wuqub'** raqan alanxax; xusipaj **jumuch' kajlajuj** chikiwach nik'aj ak'alab'. ¿Janipa' raqan alanxax xkanaj ruk' le achi?

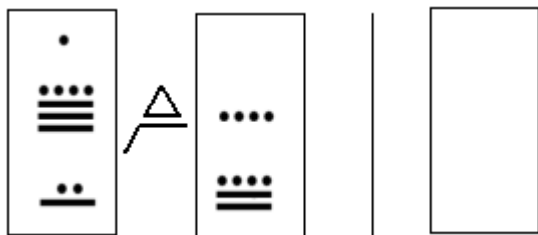

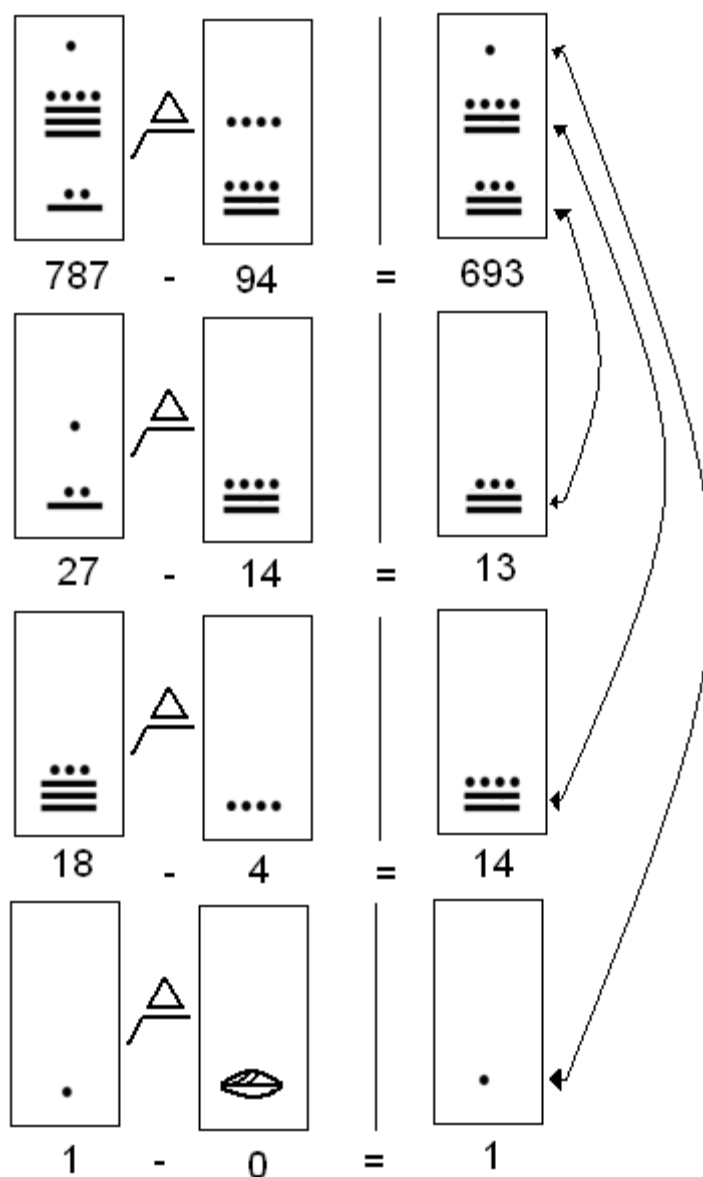

TZALIB'AL UWACH: ruk' le achi xkanaj juq'o' kajlajk'al oxlajuj raqan alanxax.

ch) Jun ali e k'o **b'elejk'al wajxaqib'** raqan rak', xe'kam **jo'k'al b'elejlajuj** chikech le e rak'. ¿E jorapa' rak' le jun ali e k'aslik?

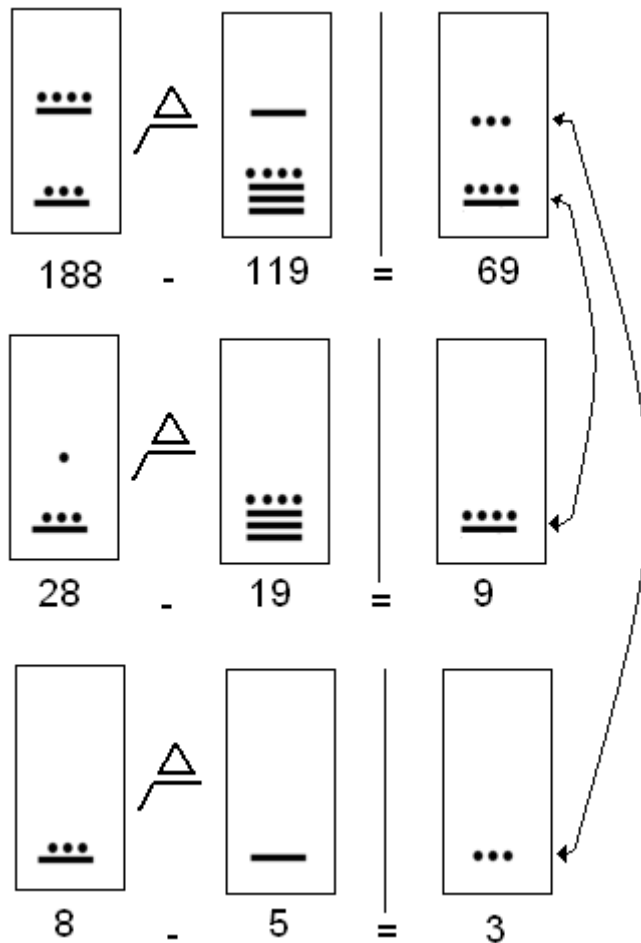
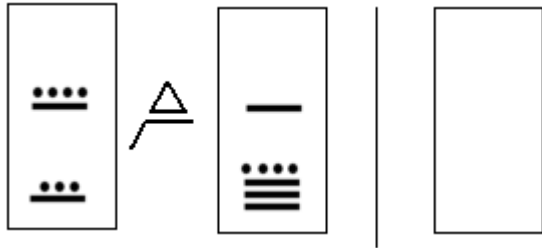

TZALIB'AL UWACH: e oxk'al b'elejeb' le rak' le jun ali ek'aslik.

ch') Pa jun ja tijob'al rech ukab' eta'manik e k'o **juq'o' juwinaq** ajtijoxelab'; xkitzaq kijunab' **wajxaqk'al waqib'** ajtijoxelab'. ¿E joropa' ajtijoxelab' xkich'ek kijunab' pa le jun ja tijob'al rech ukab' eta'manik?

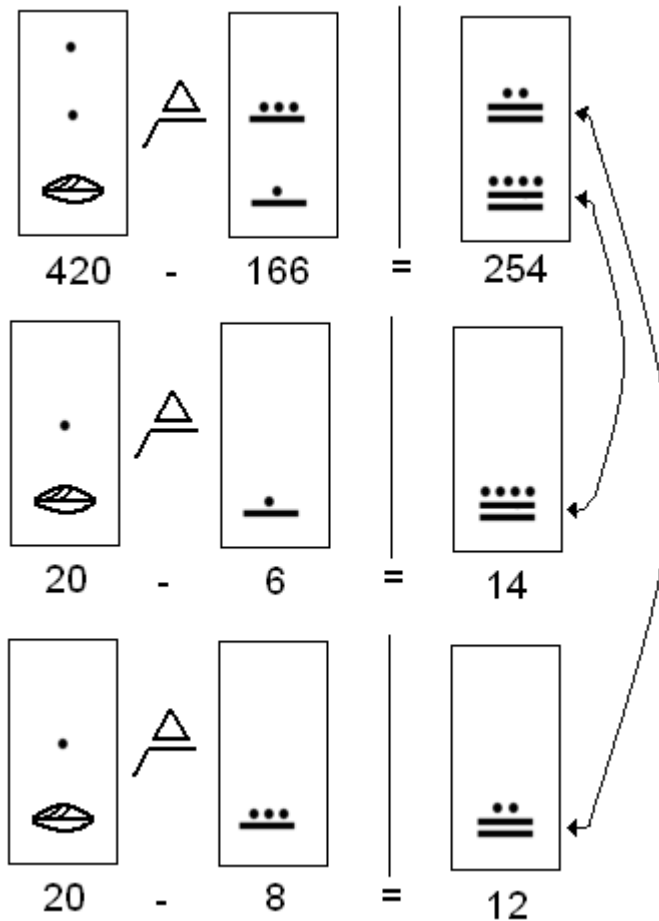
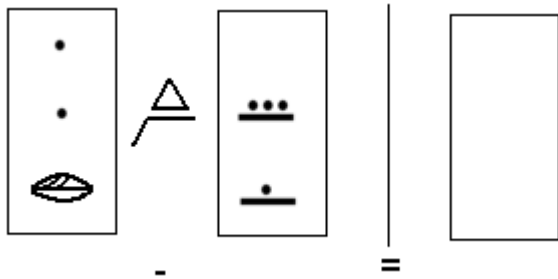

TZALIB'AL UWACH: Pa le jun ja tijob'al rech ukab' eta'manik **ekab'lajk'al kajlajuj** ajtijoxelab' xkich'ek kijunab'.

e) Jun achi xumulij **oxq'o' jo'k'al b'elejlajuj** ketzal rech k'ayij re jun q'ij; le uch'ekoj le jun achi **b'elejlajk'al lajuj ketzal**. ¿Joropa' ketzal ukapital le jun achi?

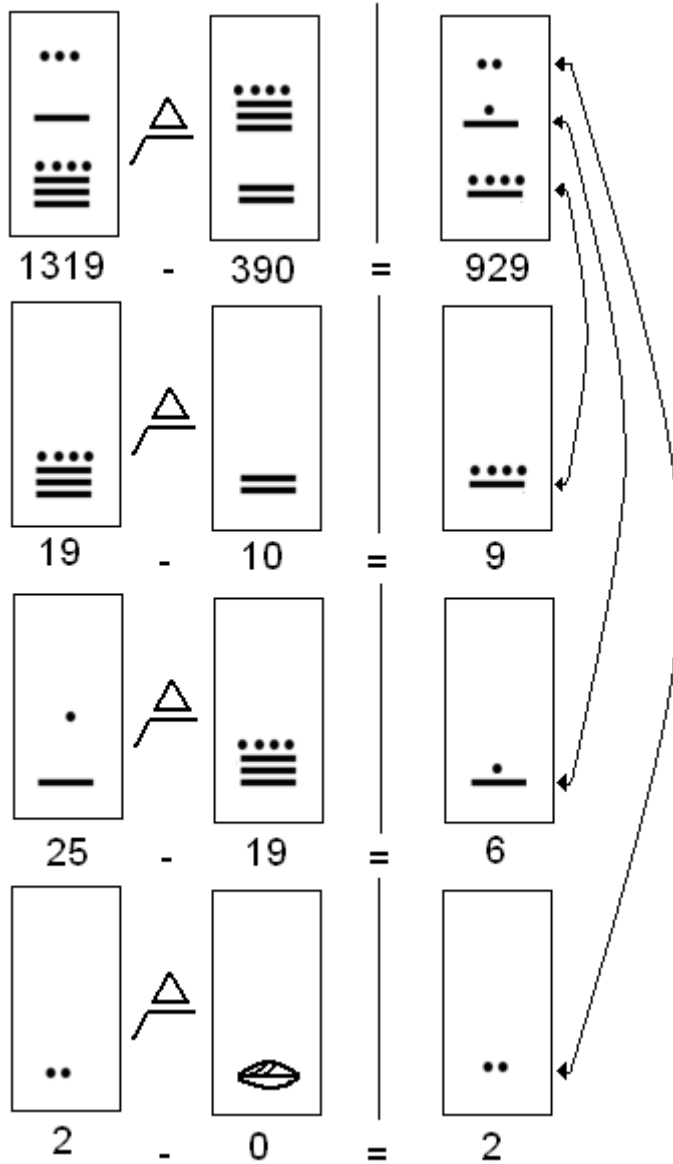
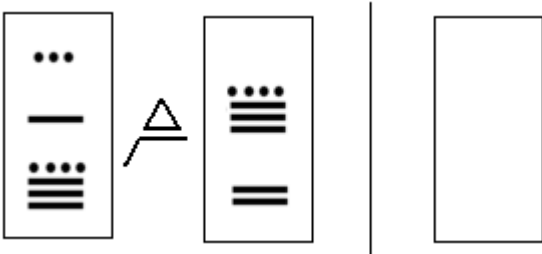

TZALIB'AL UWACH: le ukapital le jun achi **kaq'o' waqk'al b'elejeb'**.

CHAK:

Chasolij le jalajoj taq esanem. Chatzukuj le tzalib'al uwach.

- a) Jun achi xuloq' jun uch'ich' chi **jochuy** q'uj' (40,000), naj xk'oji'na ruk' k'ate ri' xuk'ayij, chi kachuy oxq'o' q'uj' (17,200). ¿Janipa' q'uj' xutzaq le achi?

TZALIB'AL UWACH: le jun achi xutzaq _____ q'uj'.

- b') Jun achi xuk'am **wuqlajq'o' jolajk'al** q'uj' (6,700), xuloq' jastaq rech uk'ay, xu'sacha' **julajq'o' b'elejlajk'al keb' q'uj'** (4782). ¿Janipa' q'uj' man xusach taj ri achi?

TZALIB'AL UWACH: le jun achi man xusach taj _____ q'uj'.

ch) Jun ala uk'as **juq'o'** q'uq' (400) che le utat, xutzalij **waqk'al waqlajuj** (136) q'uq' che le utat. ¿Janipa' q'uq' uk'as na le jun ala?

TZALIB'AL UWACH: le jun ala uk'as na _____ q'uq'.

ch') Ri e k'amalb'e rech jun wokaj rech ja' xkimulij **kachuy** q'uq' (16,000), xeb'ek chuloq'ik jastaq le kajawataj chech taq le chak okisab'al ja', xe'kisacha' **juchuy kaq'o' waqlajk'al** (9,120) q'uq'. ¿Janipa' pwaq xkanajik?

TZALIB'AL UWACH: xkanajik _____ ketzal.

- e) Jun chuchu' xuk'amb'ik pa k'ayib'al **kajq'o' jo'k'al** (1700) raqan oj, xuk'ayij **kaq'o' b'elejk'al wajxaqib'** (988) raqan oj. ¿Janipa' oj man xuk'ayij taj le chuchu'?

TZALIB'AL UWACH: Le jun chuchu' man xuk'ayij taj _____raqan oj.

6.3. K'IYARSANEM

Le k'iyarsanem, kuk'utwachij jampa' jun ajilab'al kk'iyik. Pa taq le jalajoj taq qarajawaxik teren wi le k'iyarsanem. Jacha'tane are kb'an le moloj, le kuchuj, le tob'anik.

Le retab'alil le k'iyarsanem are le jun wachib'al kuk'utwachij le jun k'ix.

Qilampe' jun k'amb'al no'j, rech kqe'tamaj jas kqab'an chech le uchakuxik le k'yarsanem.

Cha k'yarsaj le jule' ajilab'al mayab'.

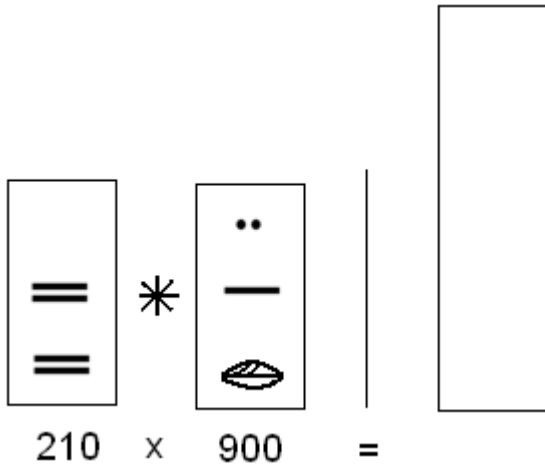

- Nab'e kqasolij le ajilab'al k'o pa qamox, rech kqilo janipa' rajilb'alil xuquje' kqilo le ajilab'al k'o pa qawiqiq'ab'.
- Le ajilab'al k'o pa qamox pa le nab'e k'olib'al kk'iyisax ruk' le ajilab'al k'o pa le qawiqiq'ab'. Le kel chqawach kqaya chuxukut.
- Le ajilab'al k'o pa qamox pa le ukab' k'olib'al kk'iyisax ruk' le ajilab'al k'o pa le qawiqiq'ab'. Le kel chqawach kqaya chuxukut le ajilab'al xqariq kan nab'e, kapaqab'a' jun k'olib'al, k'ate ri' kqatunu.
- Le ajilab'al kuya chijunamal are' la' le tzalib'al uwach rech le k'yarsanem.

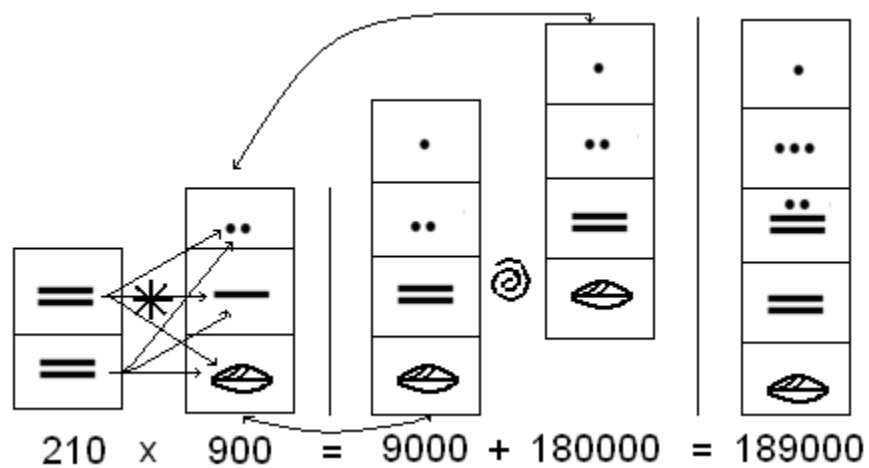

CHAK:

Chasolij le jalajoj taq k'yarsanem. Chatzukuj le tzalib'al uwach.
Chakojo retal le ub'eyal usuk'umal xqab'ij kanoq.

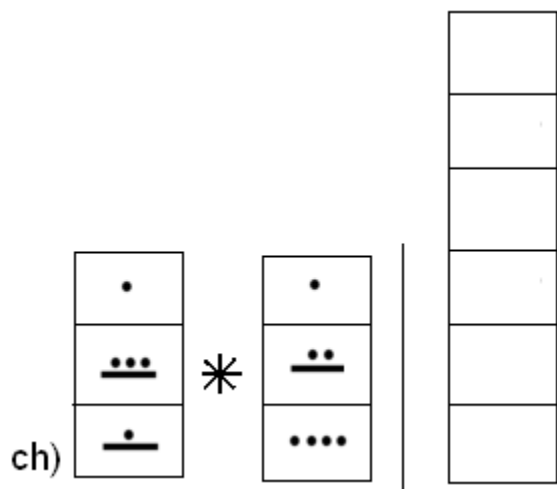
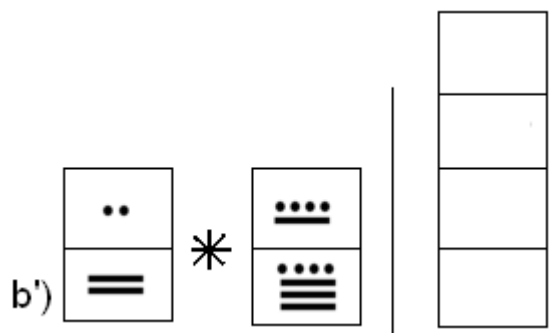
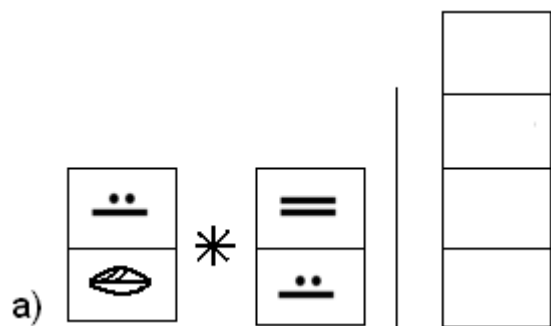

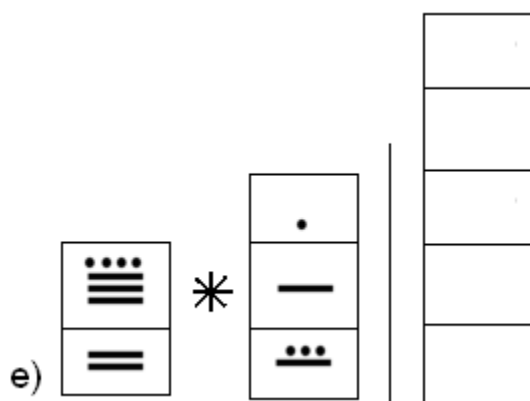
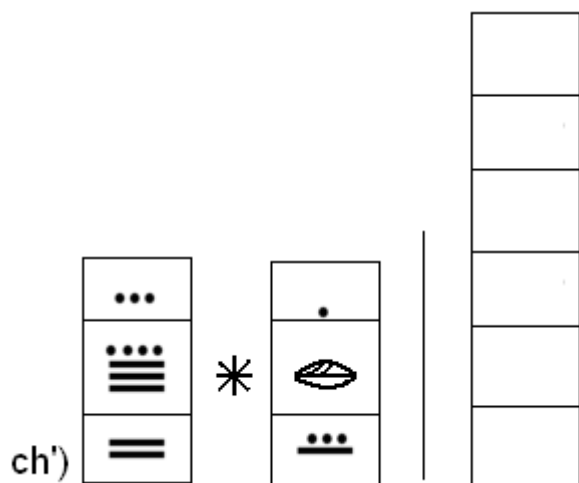

CHAK:

Chasolij le jalajoj taq k'yarsanem. Chatzukuj le tzalib'al uwach.

a) Jun pwi' rajil **kawinaq job'** ketzal. ¿Janipa' ketzal rajil **juq'o'** pwi'?

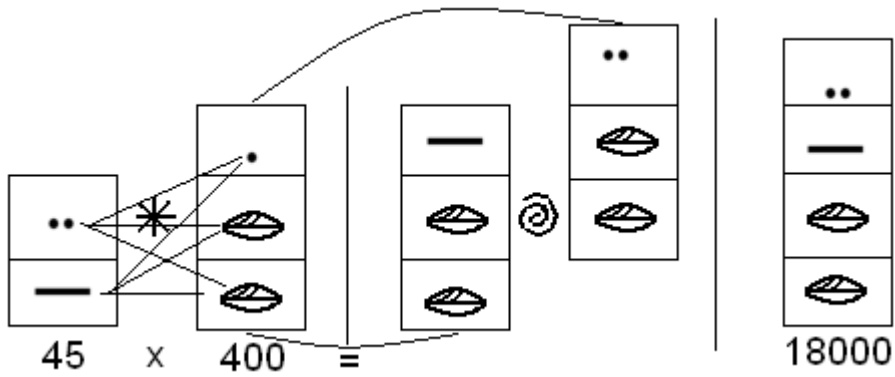

TZALIB'AL UWACH: le juq'o' pwi' rajil **kachuy jo'q'o'** q'uq'.

b') Jun kintal ixim rajil **waqk'al** q'uq'. ¿Janipa' kqatojo we kqaloq' **oxk'al jo'lajuj** kintal ixim?

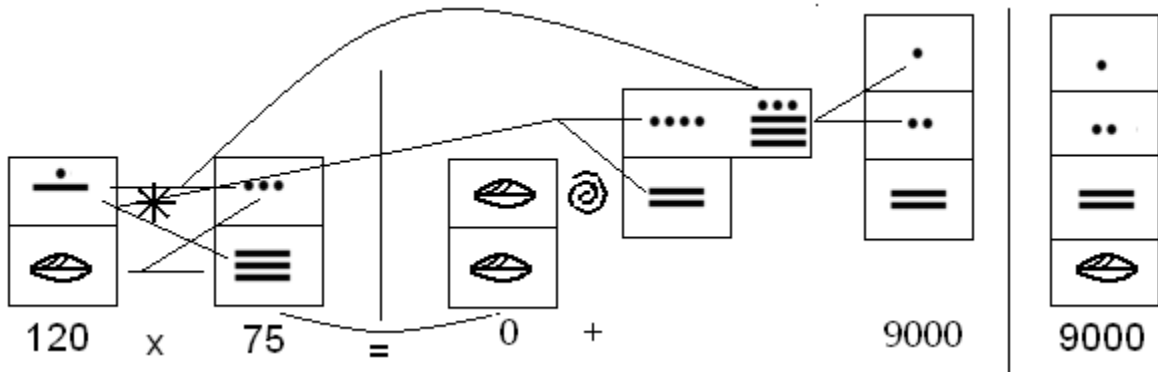

TZALIB'AL UWACH: le achi xumulij **juchuy kaq'o' lajk'al** ketzal.

ch) Jun kintal saqwach rajil **lajk'al lajuj** ketzal. ¿Janipa' rajil **kaq'o' jo'k'al** kintal saqwach?

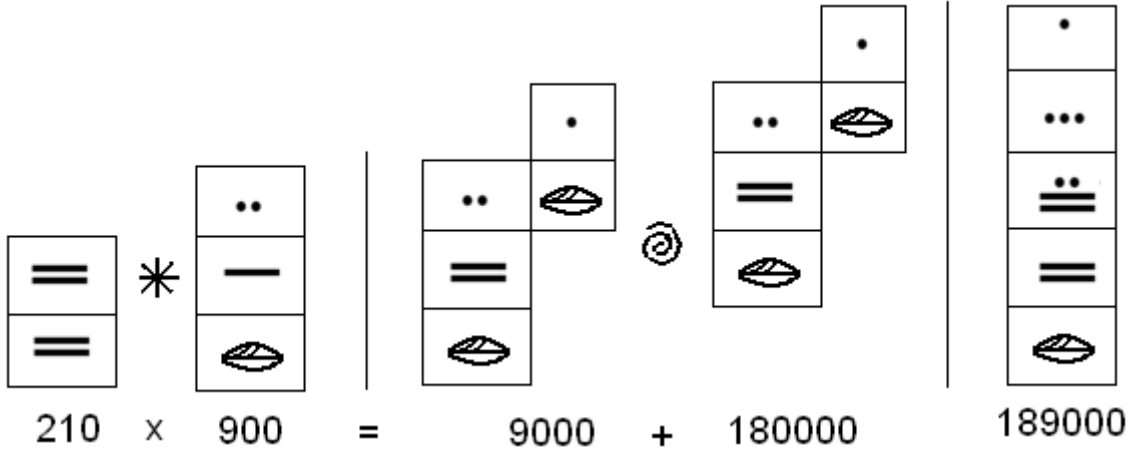

TZALIB'AL UWACH: Le kaq'o' jo'k'al kintal saqwach rajil **juk'ala', oxchuy, kab'lajq'o'**, lajk'al ketzal.

ch') Pa jun ja tijob'al rech ukab' eta'manik e k'o **juq'o' juwinaq** ajtijoxelab'. ¿Janipa' pwaq kmulitaj pa jun ik' we le ajitjoxelab' kkitoj **juwinaq lajuj** ketzal pa kijujunal?

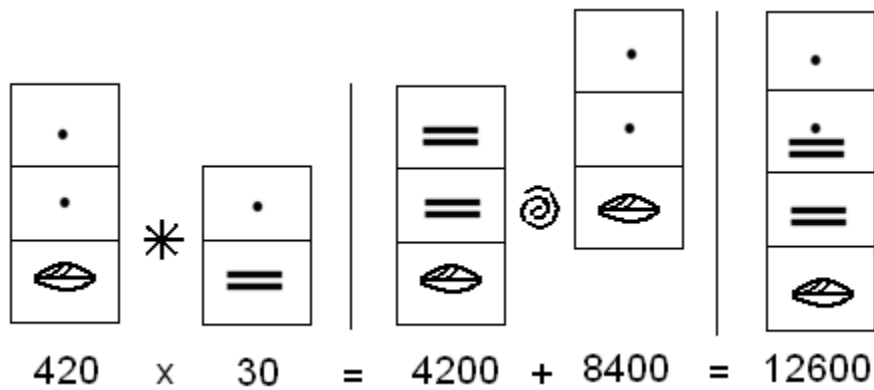

TZALIB'AL UWACH: Kamulitaj **juchuy julajq'o'** lajk'al ketzal pa jun ik'.

e) Jun ch'ich' kutij **juwinaq jo'lajuj** galon gasolina pa jun q'ij. ¿Janipa' galon gasolina kutij le jun ch'ich' pa **jo'k'al bélejeb'** q'ij?

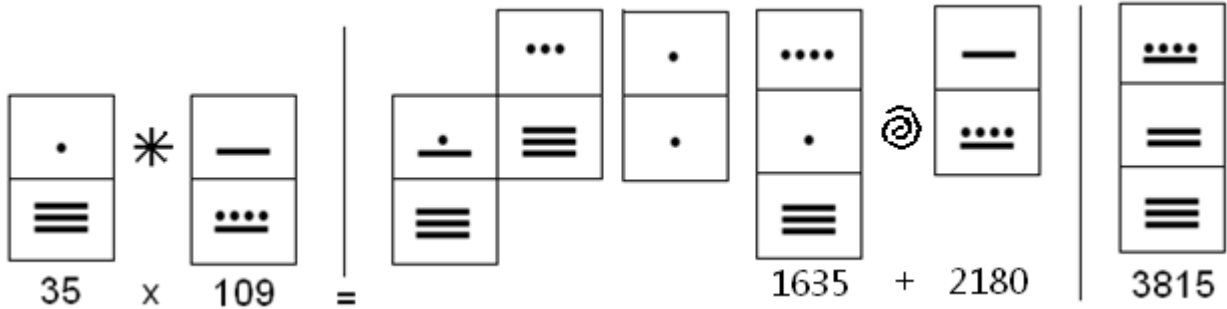

TZALIB'AL UWACH: le jun ch'ich' kutij **b'elejq'o'**, **lajk'al jo'lajuj** galon gasolina.

CHAK:

Cha solo' uwach le jalajoj taq chak, k'ate ri' katzukuj le tzalib'al uwach.

Chawila le jalajoj taq k'amb'al no'j xqil kanoq.

a) Jun achi kuch'eko **kawinaq** ketzal pa jun uq'ij. ¿Janipa' q'uq' kuch'ek pa oxib' ik'?

TZALIB'AL UWACH: le jun achi kuch'eko _____ q'uq' pa oxib' ik'.

b') Jun libra kinaq' rajil **waqib'** ketzal. ¿Joropa' rajil **job'** kintal kinaq'?

TZALIB'AL UWACH: Le job' kintal kinaq' rajil _____ ketzal.

ch) Jun achi xuk'ayij **juwinaq** k'a'm rulew chi oxk'al ketzal jujun k'a'm.
¿Janipa' pwaq xumulij le jun achi?

TZALIB'AL UWACH: le jun achi xumulij _____ ketzal.

ch') Jun uq rajil **juq'o'** q'uq'. ¿janipa' rajil **jumuch'** uq?

TZALIB'AL UWACH: le jumuch' uq rajil _____ q'uq'.

e) Jun tata' kuk'ayij kami'x chi **oxk'al** ketzal jujun. ¿Joropa' ketzal kqatojo we kqaloq' **kawinaq lajuj** kami'x?



TZALIB'AL UWACH: kqatojo _____ ketzal we kqaloq' kawinaq lajuj kami'x.

6.4. JACHIK

Are kjach jun jasuch, k'o kkib'ij chi kkipaq'ij uwach. Are kkijach ri echab'al ri etat nan chike ri ekalk'wa'l; ko'k chech ri ujachik le ulew, junam kb'an chike le alk'walixelab'.

Le retab'alil le jachanik are le jun wachib'al kuk'utwachij le jun ulew paq'im.

Qilampe' jun k'amb'al no'j, rech kqe'tamaj jas kqab'an chech le uchakuxik le jachik, jas le upaq'ixik le ajilab'al mayab' k'iche'.

..		=		
—		=		
		=		...
900	÷	210	=	4

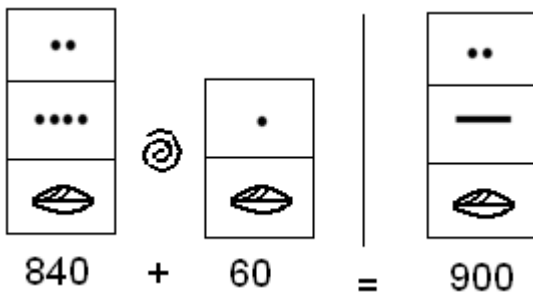
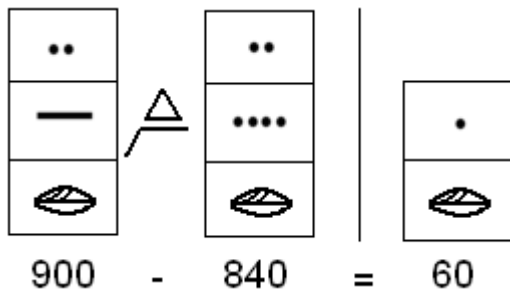
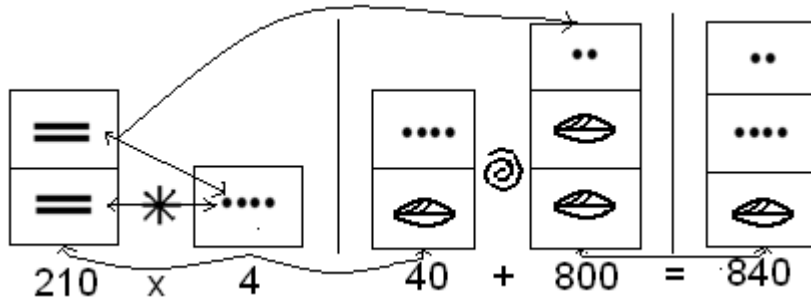

- Nab'e kaqasolij le ajilab'al k'o pa qamox, rech kqilo janipa' rajilb'alil xuquje' kaqilo le ajilab'al k'o pa qawiqq'ab'.
- Le ajilab'al k'o pa qamox are kjach chech le ajilab'al k'o pa le qawiqq'ab'. Le kel chqawach kqaya chuxukut.
- Pa le k'amb'al no'j kaqilo chi le rajilb'alil le ajilab'al kjachik are le kaq'o' jo'k'al chech le lajk'al lajuj.
- We kqajunamaj le keb' ajilab'al kqilo chi le nab'e ajilab'al kajib' mul nim choch le ukab' ajilab'al, xaq je ri' kaqachomaj chi kuya'o kqaya kajib' chech.

- We kqak'iyarsaj le lajk'al lajuj ruk' le kajib', ku'tzaqa' chi qawach, kaq'o' kawinaq, are wa' le kuk'utwachij ronojel le xqajacho.
- Pa we k'amb'al no'j kaqilo chi xkanaj kan oxk'al ajilab'al ri man xjach taj. Wa ta xjach job' chech le lajk'al lajuj ajilab'al, man ku'tzaqata chik le ajilab'al, rumal che ri xa kik'owik choch le ajilab'al kaq'o' jok'al kqaj kqajacho.
- We kqatunu le kaq'o' kawinaq ruk' le oxk'al xkanaj kanoq, kutzaqa' kaq'o' jok'al, xaq je ri' xqariq le ajilab'al le xqajach ajsik.
- Jacha le k'amb'al no'j tajin kqilo man xk'is taj ronojel chu jachik.
- K'o jun taq mul are kb'an le jachanik, tz'aqat ke'loq, maj kkanaj kanoq.

CHAK:

Chajacha' le jalajoj taq ajilab'al mayab' k'iche'.

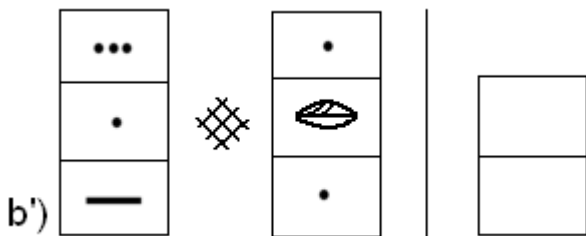
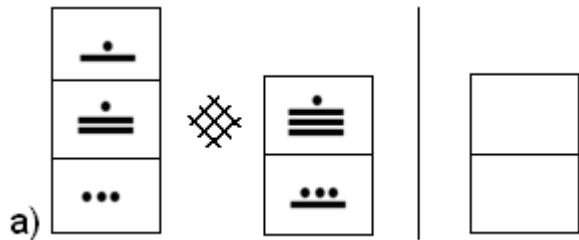

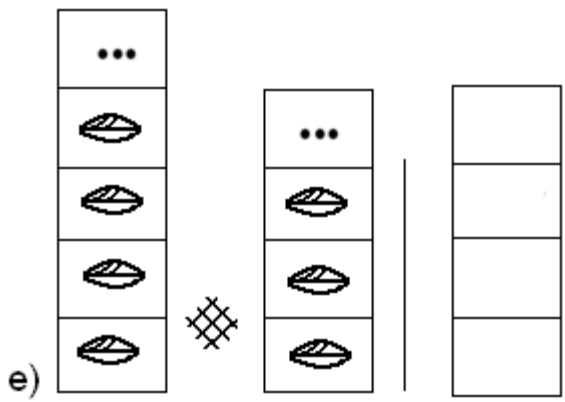
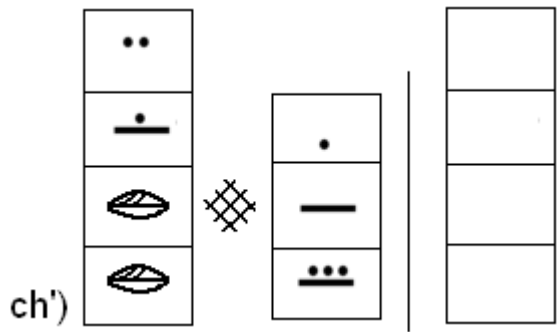
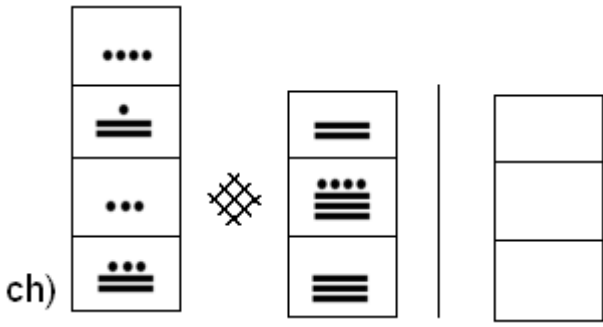

CHAK:

Chab'ana' le jachanik pa le ajilab'al mayab'.

a) Jun tata' k'o **kab'lajq'o' lajk'al** (5000) q'uq' ruk', kraj kujacho chike le **wuqub'** ralk'wa'l. ¿Janipa' q'uq' kuya chike chi kijujunal le ralk'wa'l?

5000 ÷ 7 = 700

700 × 7 = 0 + 2100 + 2800 = 4900

5000 - 4900 = 100

TZALIB'AL UWACH: le jun tata' kuya juq'o' jo'lajk'al q'uq' chi kijujunal le ralk'wa'l.

b) ¿Janipa' kintal ixim kqaloq'o ruk' **jo'q'o'** ketzal, we waqk'al **job'** q'uq' rajil jun kintal ixim?

2000 ÷ 125 = 16

125 = 16 = 80 + 1920 = 2000

TZALIB'AL UWACH: kuya'o kaqaloq' waqlajuj kintal ixim.

ch) **Oxib'** achyab' xkich'ek **lajq'o'** ketzal pa uwi' jun k'ayij xkib'ano.
 ¿Janipa' q'uq' kkechab'ej chi ki jujunal ri oxib' achyab' we kkijach ri pwaq chi ki wach?

4000 ÷ 3 = 1200

...	*		
☉				☉
☉		...		☉
1200	X	3	=	3600

=	△
☉		☉		☉
☉		☉		☉
4000	-	3600	=	400

TZALIB'AL UWACH: oxq'o' ketzal kkechab'ej chikijujunal ri oxib' achiyab', kkanaj kanoj juq'o' ketzal.

ch') ¿Janipa' ke'tojik e **wuqub'** achiyab' chi kijujunal we konojel xkich'ek **waqq'o' kawinaq lajuj** ketzal rumal jun chak xkib'ano?

.	⊗			
..				..
=		..		=
2450	÷	7	=	350

$$\begin{array}{|c|} \hline \\ \hline \text{••} \\ \hline \text{—} \\ \hline \text{—} \\ \hline \end{array}
 \times
 \begin{array}{|c|} \hline \\ \hline \\ \hline \text{••} \\ \hline \end{array}
 =
 \begin{array}{|c|} \hline \\ \hline \text{•••} \\ \hline \text{—} \\ \hline \end{array}
 +
 \begin{array}{|c|} \hline \\ \hline \text{—} \\ \hline \text{•••} \\ \hline \end{array}
 =
 \begin{array}{|c|} \hline \\ \hline \text{•} \\ \hline \text{••} \\ \hline \text{—} \\ \hline \end{array}$$

350 X 7 = 70 + 2380 = 2450

TZALIB'AL UWACH: Le e wuqub' achyab' **kawinaq jun q'uj'** ke'tojik chi kijujunal.

e) Jun tata' k'o **kaq'o' jo'k'al b'elejeb'** kintal azukal ruk'. Kraj kujach chike **job'** eloq'omanelab'. ¿Janipa' kintal azukal, kuya chikijujunal le eleq'omanelab'?

$$\begin{array}{|c|} \hline \text{••} \\ \hline \text{—} \\ \hline \text{•••} \\ \hline \end{array}
 \div
 \begin{array}{|c|} \hline \\ \hline \\ \hline \text{—} \\ \hline \end{array}
 =
 \begin{array}{|c|} \hline \\ \hline \\ \hline \text{•} \\ \hline \end{array}
 +
 \begin{array}{|c|} \hline \\ \hline \text{•} \\ \hline \text{☉} \\ \hline \end{array}
 +
 \begin{array}{|c|} \hline \\ \hline \text{•••} \\ \hline \text{☉} \\ \hline \end{array}
 =
 \begin{array}{|c|} \hline \\ \hline \text{••••} \\ \hline \text{•} \\ \hline \end{array}$$

909 ÷ 5 = 1 + 20 + 160 = 181

$$\begin{array}{|c|} \hline \\ \hline \text{••••} \\ \hline \text{•} \\ \hline \end{array}
 \times
 \begin{array}{|c|} \hline \\ \hline \\ \hline \text{—} \\ \hline \end{array}
 =
 \begin{array}{|c|} \hline \\ \hline \text{—} \\ \hline \text{—} \\ \hline \end{array}
 +
 \begin{array}{|c|} \hline \\ \hline \text{••} \\ \hline \text{—} \\ \hline \end{array}
 =
 \begin{array}{|c|} \hline \\ \hline \text{••} \\ \hline \text{—} \\ \hline \text{—} \\ \hline \end{array}$$

181 X 5 = 5 + 900 = 905

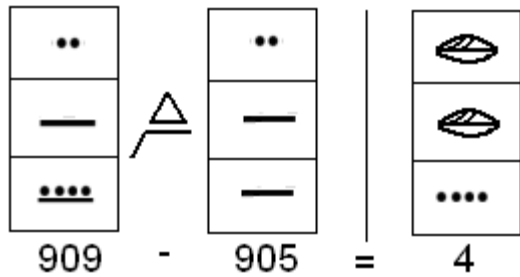

TZALIB'AL UWACH: Le jun tata' kuya **b'elejk'al jun** kintal azukal chike le eloq'omanelab'.

CHAK:

Cha solo' uwach le jalajoj taq chak, k'ate k'uri' katzukuj le tzalib'al uwach. Chawila le jalajoj taq k'amb'al no'j xqil kanoq.

- a) Jun achi kujach **juq'o' jo'lajk'al** (700) raqan xan chike oxib' umi'al. ¿Janipa' xan kuya chike ri jujun umi'al.

TZALIB'AL UWACH: le jun achi kuya _____ raqan xan chi kijujunal ri umi'al.

b') Jun kintal kinaq' rajil **juq'o' lajk'al** ketzal. ¿Janipa' ketzal rajil jun arroba kinaq'?

TZALIB'AL UWACH: Jun arroba kinaq' rajil_____ ketzal.

ch) Kjawatajik **wuqq'o' lajk'al** (3000) q'uj' rech jun chak rech jun komon. ¿Janipa' ke'qasan che le kuchuj pa jujun ja we k'o **jumuch'** (80) ja pa le komon?

TZALIB'AL UWACH: Le ke'qasan che le kuchuj pa taq le ja rech le jun komon are'_____ q'uj'.

ch') Jun ajtij k'o **jo'q'o'** (2000) tz'ib'ab'al ruk'. ¿Janipa' tz'ib'ab'al kuya chike ri e **jo'lajk'al** (300) ajtijoxelab'?

TZALIB'AL UWACH: Le jun ajtij cuya _____ tz'ib'ab'al chi ki jujunal ri ajtijoxelab'?

e) Job' achiyab' xkiloq'o jun ja chi **jo'q'o'** **jo'k'al** ketzal. ¿Janipa' xe'qasan chech le uloq'ik le ja le jujun achyab'?

TZALIB'AL UWACH: le jujun achyab' xe'qasan _____ ketzal.

- i) Jun ala xusacho **wuqq'o' wuqk'al wuqub'** (2947) ketzal puwi' **wuqub'** k'a'm ulew xuloq'o. ¿Janipa' xuya le jujun k'a'm ulew le jun ala?

TZALIB'AL UWACH: Le jujun k'a'm ulew xuya'o _____ ketzal.

7. LE ETAB'AL KOKISAX KAMIK QUMAL UJ UJMAYIB'.

Le jalajoj taq etab'al kkoj pa ronojel taq tinamit k'o le usuk'umal ya'om kumal taq le achyab' le etikowinaq loq. Le uj ujmayib' k'o jalajoj taq etab'al kqakojo chech taq le qarajawaxik. Qilampe' jujun taq etab'al:

XAQ'AB'

Are' la' le kkoj chech taq le uretaxik le kolob', le k'a'm, xuquje nik'aj jastaq chik. Le kb'an chech we jun etab'al, xa kchap le k'a'm kuk' le qawiq'ab', kqalik'ib'a' le qaq'ab' k'ate k'uri' kqatanij le k'a'm, choch le uwach qak'u'x. Jela' kb'an chech, kajilaxik joropa' ketanik le k'a'm.

JUN Q'AB'AJ

Are' la' le kkoj chech taq le uretaxik jastaq ruk' le uwi' q'ab'aj. Are' la' le kb'ix chech pa kastiy cuarta.

UXO'L AQANAJ

Are' la' le kkoj chech taq le uretaxik le ulew, are ktas kanoq le ulew kachakuxik kumal taq le ajchakib'.

CHOLAJ

Are' la' le kkoj chech taq le urajilaxik le b'olaj kumal taq le ajchakib'.

B'USAJ

Are' la' le kkoj cheh taq le urajilaxik le atz'yaq are b'ustajinaq chik. Xuquje' nik'aj jastaq chik ri kraj b'usik.

RAB'AJ

Are' la' le kkoj chech le urajilaxik le b'atz' kuk'am b'ik le q'in chikiwach le ajkemab'.

PAJB'AL JASTAQ – SATAQ-

CHAKACH

Are' le kkoj chech taq le upajik le ixim, le kinaq', le tiriko xuquje' nik'aj jastaq chik.

KOXTAR

Are' la' le kkoj chech taq le upajik le ixim, kinaq', le tiriko xuquje' nik'aj jastaq chik.

MUQ'

Are' la' le kkoj chech taq le utz'aqatisaxik le ixim, le kinaq', le tiriko,are kb'an le pajanik.

URETAXIK LE Q'IJ

PAQ'IJ

Are' la' le kb'ixik we xik'owik pa nik'aj q'ij.

AQ'AB'IL

Are' la' le kb'ixik we maja' kik'owik le nik'aj q'ij.

CHAQ'AB'IL

Are' la' le kb'ixik we xok le aq'ab'.

B'EN AQ'IJAL

Are' la' le kb'ixik are kub'an qajem le q'ij.

PAJB'AL WA JA' – JORON-

Q'EB'AL

Are' le kkoj chech taq le urerexik le ja'.

XARU'

Are' la' le kkoj chech taq le utzakik kape, q'or, katijowik.

T'U'Y

Are' la' le kkoj chech taq le tzakb'al rikil.

MULUL

Are' la' le kkoj chech taq le pajb'al q'or, pa taq le nimaq'ij kb'anik pa taq le ja.

TOL - TZIMA

Are' la' le kkoj chech taq le pajb'al ja' xuquje' le ixim, le kinaq', le tiriko.

B'O'J

Are la' le kakoj chech taq le tzakb'al tzi, xuquje' nik'aj taj taq jastaq chik. Le e qanan kakib'ij are chiko' le jun b'o' le keb' aborra upam.

PAK'

Are la' le kakikoj le e qanan are kapak'ax le rikil.

XUKURI'L

Are la' le kakoj chech taq le rikil, pa taq le tob'ik.

PAJB'AL JASTAQ RI RAJAWAXIK UREQAXIK

MULAJ

Are' la' le kkoj chech le uk'utik le jastaq mulan kanoq, rajawaxik ksik'ik, rumal la', rajawaxik kajilaxik rech man k'ota ksach chech. Rech tz'aqat kelik. Rumal la' kb'ixik, jumulaj jal, kamulaj aj, oxmulaj si', kajmulaj muchu'l.

K'AT

Are' la le kkoj chech taq le k'olib'al jastaq, kb'anb'ex taq le eqa'n, jachatane' are kerex le jal are kb'an le jach'.

CHIM

Are' la' le kkoj chech taq le k'olib'al jastaq, kb'anb'ex alaj taq eqa'n, jachatane' are kerex le jal choch taq le b'olaj are kb'an le jach'.

EQA'N

Are kb'ixik chech jun jasuch kpajan jun kintal, xa keqaxik.

IKIRA'N

Are kb'ix chech jun jasuch kpajan nik'aj kintal kk'amb'ik pataq le jolomaj.

LE URETAXIK LE UMIQ'INAL UJORONAL LE JASTAQ

K'ATAN

Are kb'ixik chech jas jun jasuch we kraqow chik. Jachatane' are kab'ixik, k'atan chik le ja'.

SIB'ALAJ K'ATAN

Are kb'ixik chech jas jun jasuch we xik'ow upaq'owik. Jachatane' are kb'ixik sib'alaj k'atan chik le ja'.

MIQ'MOJ

Are kb'ixik chech jas jun jasuch we maja' kmiq'i'k. Jachatene' are kb'ixik, xaq miq'moj le ja'.

JORIJOJ – SAQLI'

Are kb'ixik chech jas jun jasuch we man qasta joron.

SIB'ALAJ JORON -KAT'AJAJIK-

Are kb'ixik chech jas jun jasuch we xik'ow le ujononal. Xaq ne kaxuk'uk' chik le utijowokik, le ja' chuj cho'qa che.

WUJ XE'SOLIXIK CHECH LE UWOKIK WE WUJ

Casiá, Daniel y Reyes, Roselia. EL SISTEMA DE NUMERACIÓN MAYA Y SUS OPERACIONES ARITMÉTICAS. Editorial Piedra Santa 2004.

CULTURA MAYA E INTERCULTURALIDAD. Proyecto Multiplicador de Educación Maya Bilingüe Intercultural –PROEMBI-. Programa de Educación Intercultural Multilingüe de Centro América –PROEIMCA-Guatemala, mayo de 2007.

K'ulb'il Yol Twitz Paxil. K'iche' Cholchi'. K'ICHE' AJILAB'AL. Iximulew, Guatemala 1997.

MATEMÁTICA TERCERO BÁSICO. Proyecto Lingüístico Santa María. Editorial. Quetzaltenango.

Mucía Batz, José. AJIL. MATEMÁTICA VIGESIMAL MAYA. Editorial Saqb'e. Patzún, Chimaltenango, febrero de 1998.

Mucía Batz, José. KOJAJILAN. GUÍA DIDÁCTICA DE LA MATEMÁTICA MAYA. Editorial Cholsamaj. Guatemala, junio de 1999.

NO'JMAY WUJ. K'iche' Mayab' Cholchi'. Mayab' Cholchi' Rech Paxil Kayala'.

Rodríguez, Guaján y Rodríguez Guaján, José Obispo. NUMERACIÓN MAYA K'ICHE'. Proyecto Lingüístico Francisco Marroquín.

Este libro se terminó de imprimir el x de julio de 2008, en la imprenta “
“. Quetzaltenango xxxxx. Guatemala. C.A.
X Ejemplares.